

# **VS-GSWG**

## **INSTALLATION GUIDE**

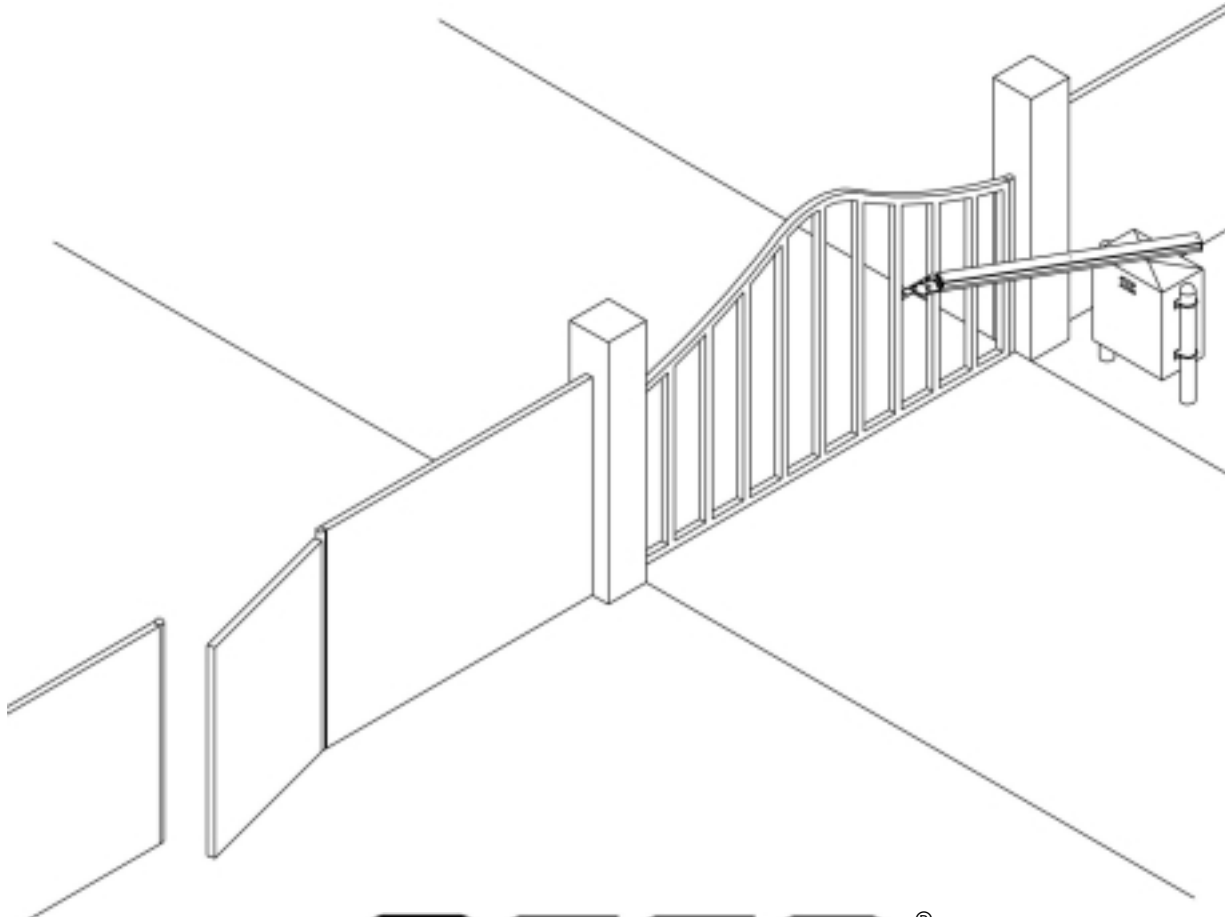

# **OSCO**<sup>®</sup>

**OPERATOR SPECIALTY COMPANY, INC.**

CASNOVIA, MI 49318 • U.S.A.



**UL325 COMPLIANCE REQUIRES THE USE OF CONTACT EDGES  
OR PHOTOELECTRIC CONTROLS ON ALL AUTOMATIC OR  
REMOTELY-CONTROLLED GATE OPERATORS.**

# VS-GSWG OPERATOR INSTALLATION GUIDE

## TABLE OF CONTENTS

<b>PRE-INSTALLATION INFORMATION</b>	
Safety Information and Warnings .....	3
Pre-Installation Information .....	3
Warranty .....	3
<b>INSTALLATION</b>	
Post Mounting Instructions .....	4
Torque Limiter Adjustment .....	5
Electrical Instructions .....	5
Limit Switch Adjustments .....	6
<b>CONTROL BOARD ADJUSTMENTS and ACCESSORY CONNECTIONS</b>	
Control Board Adjustments .....	7
Terminal Connection Descriptions .....	8
Current Sensing Adjustments .....	9
Close Direction Current Sense Adjustment .....	9
Open Direction Current Sense Adjustment .....	9
Maximum Run Timer Adjustment .....	9
Auto Close Timer Adjustment .....	9
Master/Slave Connection .....	9
Onboard L.E.D. Indicator Descriptions .....	10
Important Notes for Installation of Master/Slave Applications .....	11
Surge Protector Instructions .....	11
Ordering Replacement Parts .....	11
Control and Accessory Connection Illustrations .....	12-15
<b>ILLUSTRATIONS</b>	
Loop Layout Illustration .....	16
Edge Layout Illustration .....	17
Photo Eye Illustration .....	18
<b>PARTS LISTS</b>	
Model VS-GSWG Mechanical Parts Exploded View .....	19
Model VS-GSWG Mechanical Parts List .....	20
Model VS-GSWG Control Box Exploded View and Parts List - AC Tech .....	21
Programming Instructions for Variable Speed Drive - AC Tech .....	22
Model VS-GSWG Control Box Exploded View and Parts List - Hitachi .....	23
Programming Instructions for Variable Speed Drive - Hitachi .....	24
Model VS-GSWG Gate Arm Assembly Parts List .....	25
<b>WIRING SPECIFICATIONS</b> .....	26
<b>PREVENTATIVE MAINTENANCE</b> .....	27
<b>GATE OPERATOR INSTALLATION CHECKLIST</b> .....	30

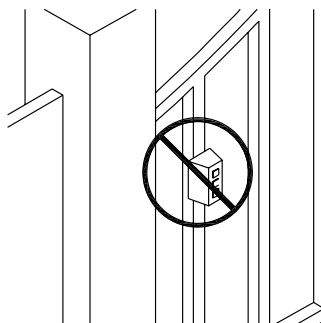

**CAUTION!**  
DO NOT INSTALL  
CONTROLS ON OR  
NEAR THE GATE

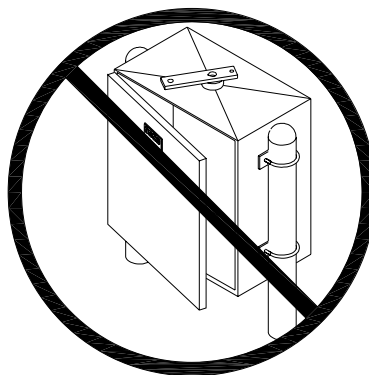

**CAUTION!**  
ONLY QUALIFIED SERVICE  
TECHNICIANS SHOULD  
WORK ON AN OSCO  
SWING GATE OPERATOR

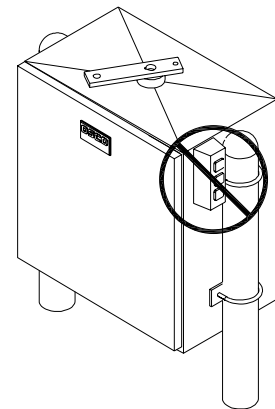

**CAUTION!**  
DO NOT INSTALL  
CONTROLS ON  
THE OPERATOR

# VS-GSWG OPERATOR INSTALLATION GUIDE

## GATE OPERATOR CLASSIFICATIONS

All gate operators can be divided into one of four different classifications, depending on their design and usage.

### **Class I Residential Vehicular Gate Operator**

A vehicular gate operator intended for use in a home of one to four single family dwellings, or garage or parking area associated with these dwellings.

### **Class II Commercial / General Access Vehicular Gate Operator**

A vehicular gate operator intended for use in a commercial location or building such as a multifamily housing unit of five or more single family units, hotel, retail store or other building servicing the general public.

### **Class III Industrial / Limited Access Vehicular Gate Operator**

A vehicular gate operator intended for use in an industrial location or building such as a factory or loading dock area or other location not intended to service the general public.

### **Class IV Restricted Access Vehicular Gate Operator**

A vehicular gate operator intended for use in a guarded industrial location or building such as an airport security area or other restricted access locations not servicing the general public, in which unauthorized access is prevented via supervision by security personnel.

## **IMPORTANT!!**

Before installing the gate operator, make sure the gate's swing is free and level throughout the entire swing path. If the gate does not seem to operate properly, it may affect the operator performance or greatly shorten the life of the unit. The gate should be designed so that airflow is ample to prevent wind resistance and drag.



## SAFETY INFORMATION AND WARNINGS

Read the following before beginning to install OSCO swing gate operators:

1. Read the orange "Safety Instructions" brochure enclosed with the packet of information. If you do not have one, please call OSCO at 1-800-333-1717 to request one. Read and follow all instructions.
2. All electrical connections to the power supply must be made by a licensed electrician and must observe all national and local electrical codes.
3. A separate power-disconnect switch should be located near the operator so that primary power can be turned off when necessary.
4. Install the enclosed warning signs on both sides of the gate. Each sign must be plainly visible from the side of the gate on which they are mounted.
5. Never reach between, through or around the fence to operate the gate.
6. You must install all required safety equipment.

## PRE-INSTALLATION INFORMATION

Before unpacking, inspect the carton for exterior damage. If you find damage, advise the delivery carrier of a potential claim. Inspect your package carefully. You can check your accessory box parts with the enclosed packing slip for your convenience. Claims for shortages will be honored for only 30 days from the date of shipment.

Before installing the operator, read this manual completely to ensure all requirements for proper installation are present. Verify that the voltage to be used matches the voltage of the operator.

**The following contact or non-contact obstruction detection devices have been approved for use with OSCO slide gate operators as part of a UL325 compliant installation:**

**Contact Edges:**

Miller Models\*: MG0-20, MGR-20, MGS-20, and ME-120

**Photoeyes:**

2520-441 MMTC Model IR-55 photoeye, 165' with mounting hardware

2520-031 MMTC Model E3K photoeye, 28' with mounting hardware

*\*for OSCO part numbers, contact a sales representative for details*

# VS-GSWG OPERATOR INSTALLATION GUIDE

## POST MOUNTING INSTRUCTIONS FOR MODEL VS-GSWG

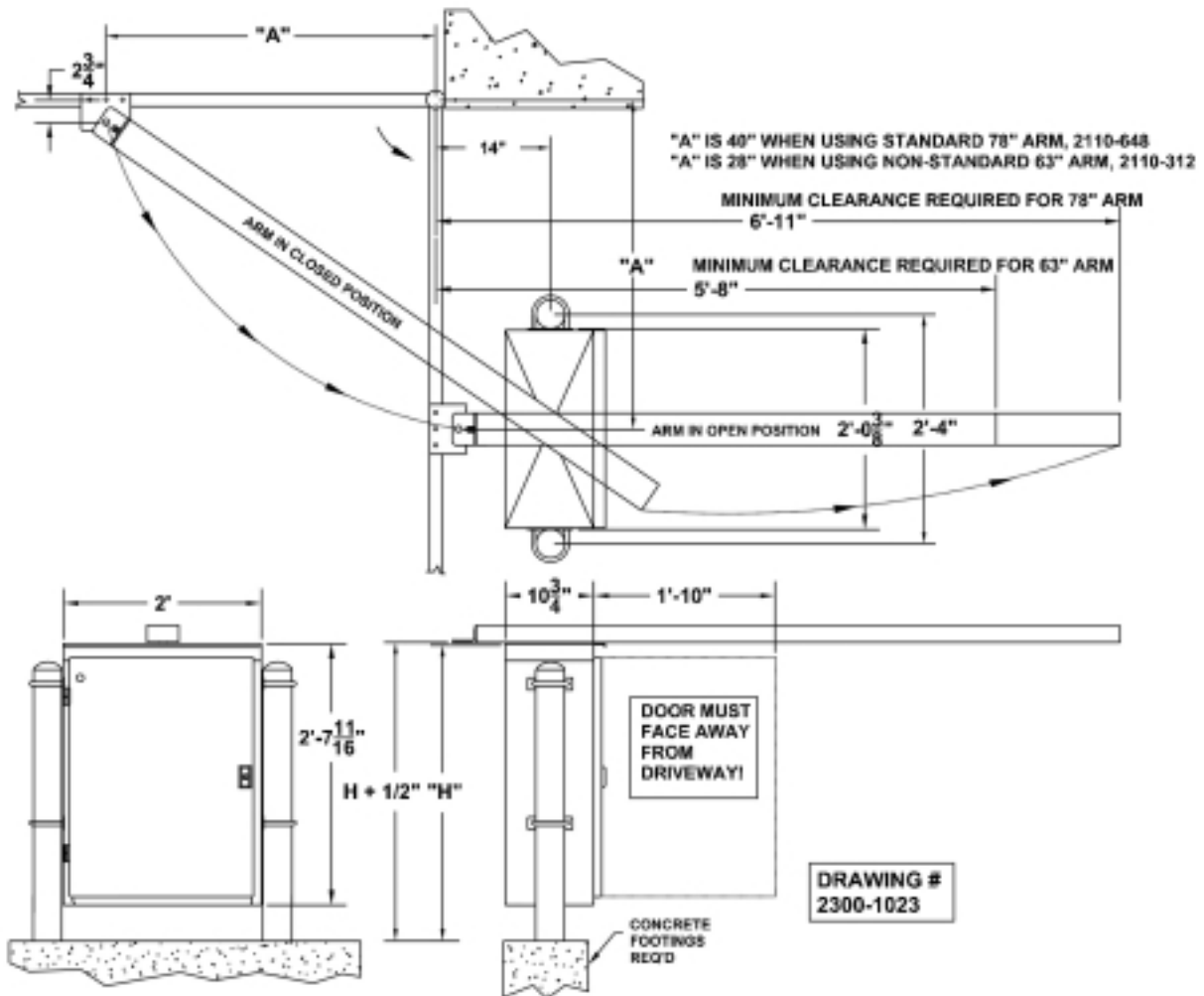

Use two 3 - 3 1/2" diameter galvanized posts and secure with concrete footings as shown, length to be determined by local codes, frost line depth, and soil conditions.

Attach the operator with the U-bolts, side plates and hardware provided. There are four side plates. The 3/16" side plates go on the inside top of the operator, while the two 1/2" side plates go on the inside bottom (see the illustration at right). The operator should be positioned at a level to allow the arm to be installed at mid-height on the gate. "H" dimension can vary depending on gate construction. Make sure the posts do not protrude above the operator cabinet.

**IF NONSTANDARD MOUNTING IS NECESSARY, CONSULT THE FACTORY**

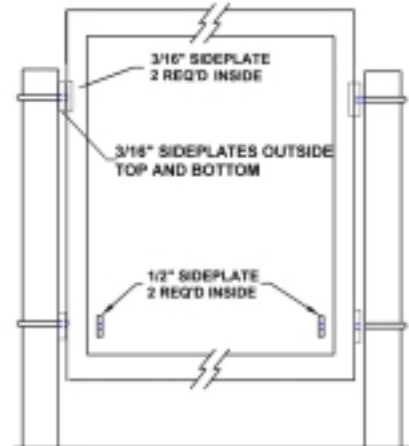

**A SEPARATE PEDESTRIAN GATE IS REQUIRED FOR ALL PEDESTRIAN TRAFFIC. THIS GATE MUST BE A MINIMUM DISTANCE OF 7 FEET FROM THE VEHICULAR GATE AND GATE OPERATOR**

# VS-GSWG OPERATOR INSTALLATION GUIDE

**DISCONNECT POWER FROM THE OPERATOR  
BEFORE MAKING ADJUSTMENTS!**

## Arm Assembly

1. Remove the arm assembly cover.
2. Place the center hole in the rail guide over the 1" drive shaft.
3. Place the drive sprocket on drive shaft. Be sure the keyway is in place and set screws are secured.
4. Connect the gate bracket to the gate. Manually open the gate to approximately half-open position.
5. String the arm assembly chain as shown in the diagram at right.
6. Adjust for taut chain tension but do not overtighten.
7. Replace the cover.

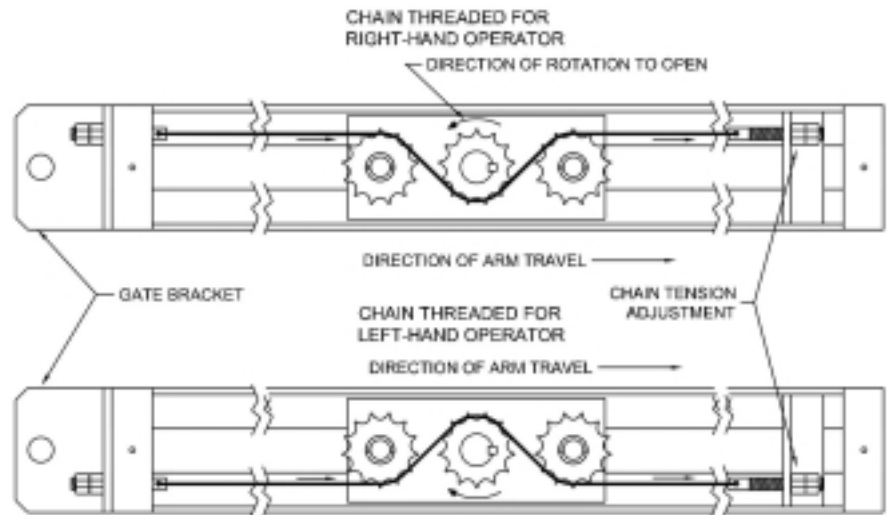

## TORQUE LIMITER ADJUSTMENT

The torque limiter is set light at the factory. **It must be adjusted during installation and checked on a regular basis.** Before adjusting the torque limiter, make sure the gate is in good working condition. Be certain the gate moves freely and without binding throughout its entire travel.

**NOTE:** The torque limiter should be set tight enough so that when the operator starts and is in normal operation, the torque limiter does not slip, but loose enough to slip if the gate is obstructed.

1. Loosen the set screw on the adjustment nut.
2. **To increase the output**, turn the adjustment nut clockwise one flat, or 1/6 turn, at a time until desired output is obtained.

**WARNING:** Do not overtighten. The torque limiter must slip if the gate is obstructed.

**To reduce the output**, turn the adjustment nut counterclockwise one flat, or 1/6 turn, at a time until desired output is obtained.

**NOTE:** A properly adjusted torque limiter will not slip during normal operation.

3. Retighten the set screw on the adjustment nut.

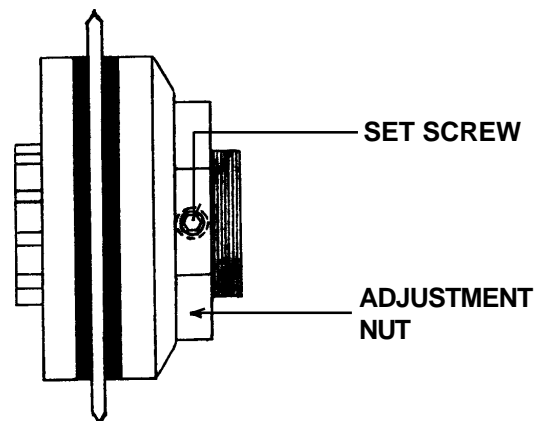

### IMPORTANT

- A. Power supply must be of correct voltage and phase.
- B. Always disconnect power from operator before servicing.
- C. Keep clear of gate during operation.

## ELECTRICAL INSTRUCTIONS

You'll find the complete electrical circuit print inside the operator cover. The power supply must be ample and not taken from an overloaded line, as faulty operation will result. The supply must be of correct voltage and phase. For proper wire gauge, refer to "**Wiring Specifications**" on page 26.

Proper thermal protection is supplied with the operator. The motor contains a thermal overload protector (single phase) to protect from overheating the motor due to overload or high-frequency operation.

# VS-GSWG OPERATOR INSTALLATION GUIDE

## LIMIT SWITCH ADJUSTMENT

(For Right Hand Operation, Left Hand Opposite)

Refer to the Illustration below when following these instructions.

Adjust the limit nuts by depressing the detent plate and turning the nuts in the desired direction of travel. To allow for additional travel in the open direction, for instance, rotate the open limit nut so that it moves to the left on the shaft. To allow for greater travel in the close direction, rotate the close limit nut so that it moves to the right on the shaft.

### Special Notes for Setting Speeds using LSO-2 & LSC-2:

Limit switches LSO-2 and LSC-2 control when the operator accelerates to maximum speed and decelerates to minimum speed. It is recommended that LSO-2 and LSC-2 are adjusted first\* so the gate slows to near stop before hitting LSO-1 or LSC-1 as these will apply the brake upon activation.

\* These are adjusted by slightly loosening the two screws which hold them in place and sliding toward or away from the center of the limit box. Care must be taken not to adjust too close to the center as the limit nut may travel past the switch and start accelerating at the end of the cycle.

## PICTURE OF FOUR SWITCH ROTARY LIMIT BOX

2520-453

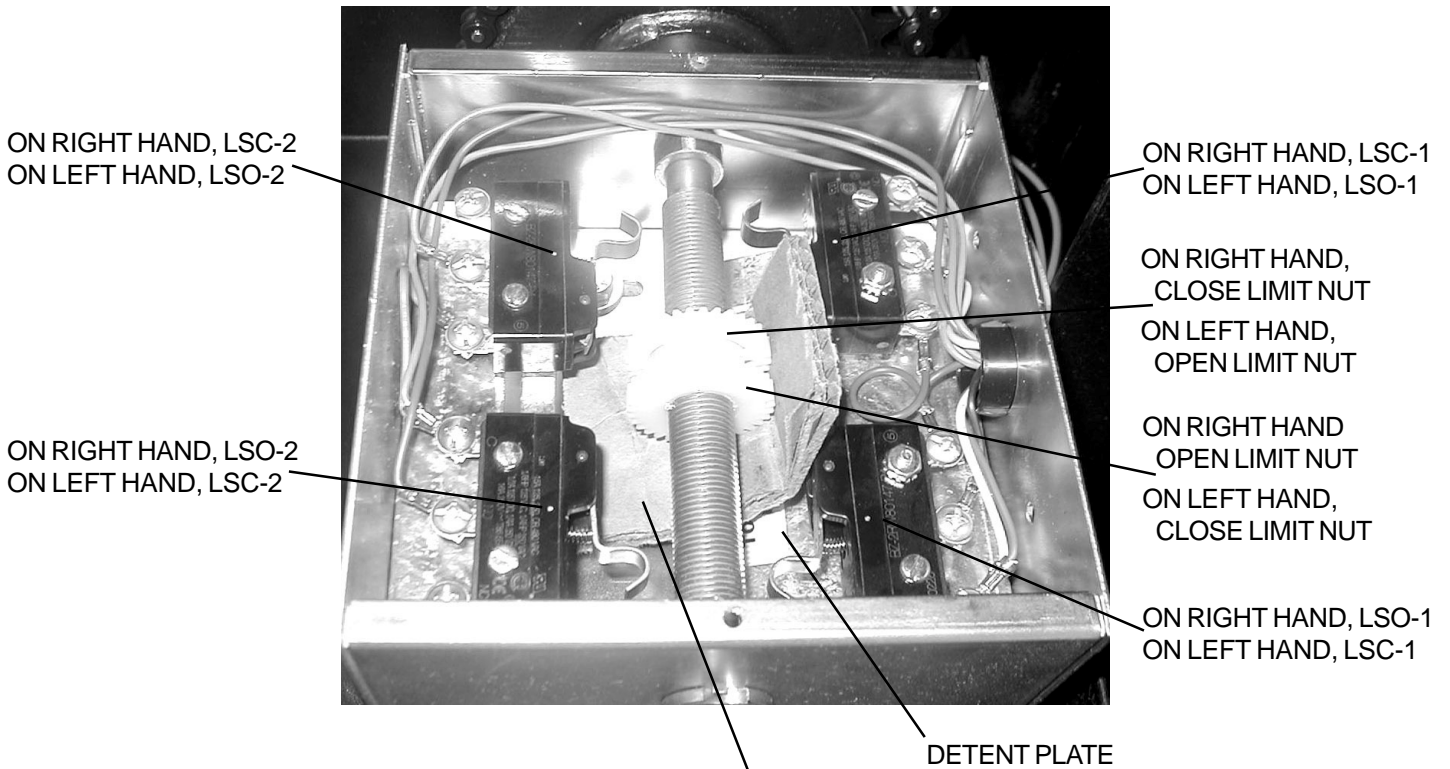

ON RIGHT HAND, LSC-2  
ON LEFT HAND, LSO-2

ON RIGHT HAND, LSC-1  
ON LEFT HAND, LSO-1

ON RIGHT HAND,  
CLOSE LIMIT NUT  
ON LEFT HAND,  
OPEN LIMIT NUT

ON RIGHT HAND, LSO-2  
ON LEFT HAND, LSC-2

ON RIGHT HAND  
OPEN LIMIT NUT  
ON LEFT HAND,  
CLOSE LIMIT NUT

ON RIGHT HAND, LSO-1  
ON LEFT HAND, LSC-1

DETENT PLATE

LSO-1 AND LSC-1 CONTROL GATE  
FULL OPEN AND CLOSE

**REMOVE CARDBOARD BEFORE  
ADJUSTING OR RUNNING OPERATOR!!**

LSO-2 AND LSC-2 CONTROL GATE  
OPERATOR RAMP UP AND DOWN

# VS-GSWG OPERATOR INSTALLATION GUIDE

## CONTROL BOARD ADJUSTMENTS

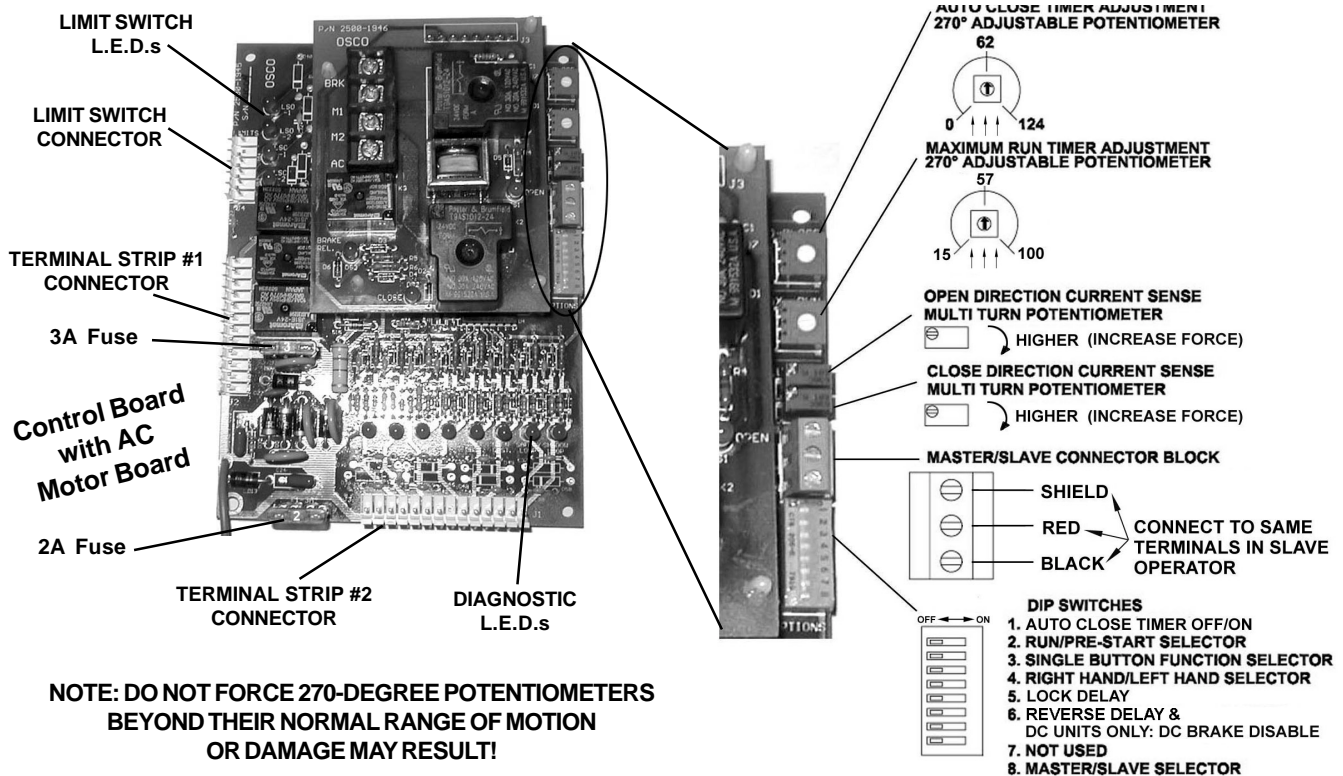

**Auto Close Timer Adjustment:** This 270-degree adjustable potentiometer will signal the operator to close automatically, provided no open, reversing or obstruction signals are present from the fully-open position. This timer is adjustable from 0 to 124 seconds. This feature is turned on or off using dip switch #1.

**Maximum Run Timer Adjustment:** This 270-degree adjustable potentiometer will signal the operator to stop running once it counts down, unless a limit switch is reached or an input is received first. Each time the motor starts, this timer will begin counting. This timer is adjustable from 15 to 100 seconds. If the timer expires, the unit locks out and the emergency alarm sounds.

**Open Direction Current Sense Adjustment:** This multi-turn potentiometer is used to calibrate the built-in current sensing feature for detection of obstructions while running in the open direction.

**Close Direction Current Sense Adjustment:** This multi-turn potentiometer is used to calibrate the built-in current sensing feature for detection of obstructions while running in the closed direction.

**Master/Slave Connection Block:** This terminal block is used in conjunction with two operators to configure two gates to open and close together.

### Dip Switches:

- #1 This switch turns the auto close timer off/on.
- #2 This switch is used in conjunction with alarms and flashing lights that may be added to the operator. When the switch is in the **ON** position, these devices will start approximately two seconds prior to the operator starting. In the **OFF** position, the devices will only work while the operator is running.
- #3 This switch is used in conjunction with single-button controls and radio receivers. In the **ON** position, successive inputs will cause signals in the order of **OPEN-STOP-CLOSE-STOP**. In the **OFF** position, inputs will cause an **OPEN** signal unless the gate is fully open, in which case it will signal **CLOSE**.
- #4 This switch determines right-hand vs. left-hand behavior. When looking from inside the protected area toward the gate, the side of the drive the operator is on determines its hand of operation. In the **OFF** position, the operator is set for right-hand.
- #5 When turned **ON**, this switch will allow a one-second delay for solenoid locks to unlock before the motor starts.
- #6 In the **ON** position the reverse delay is three (3) seconds. In the **OFF** position the reverse delay is one and a half (1 1/2) seconds.
- #7 Not used at this time.
- #8 This switch is used to set Master/Slave configuration. Operators which are stand-alone or master units should be set to **OFF**, while only slave units should have this switch set to **ON**.

# VS-GSWG OPERATOR INSTALLATION GUIDE

## TERMINAL CONNECTION DESCRIPTIONS

TERMINALS	FUNCTION	DESCRIPTION OF FUNCTION
24VAC 24VAC N	24VAC	Provides fused 24Volt AC power for accessories.
24VDC+ 24VDC- COMM.	24VDC	Provides fused 24Volt DC power for accessories.
1 & 4	OPEN	Opens the operator. Several accessories such as button stations, keypads, transmitters and card readers can be wired to open.
3 & 4	CLOSE	Closes the operator. Use caution when wiring accessories to these terminals. <b>The gate must be clearly visible from the location of any accessories wired to close.</b>
4 & 5	SINGLE-BUTTON	Performs the single-button function which will alternate between open and close or open, stop and close - depending on dip switch #3. (See page 7 for details.)
2 & 4	STOP	Stops the operator. If no stop button is used, a jumper is required across <b>2&amp;4</b> .
4 & 6	REVERSE	This function will cause a reversal when the gate is traveling closed and will travel back to the fully open position. Loop detectors are often wired for reverse.
4 & 50	OPEN OBSTRUCTION	This function works only while the operator is opening. Any signal to this function will cause the gate to stop, reverse a short distance, and then stop again. At this time the auto close timer is disabled, and a renewed input will be required to start the gate again. Should the gate be restarted and the signal occur again prior to reaching a limit, the gate will stop again, and this time will sound the emergency alarm and lock out.
4 & 51	CLOSE OBSTRUCTION	This function works exactly like the OPEN OBSTRUCTION, except that it will only work in the closing direction.
4 & 11	SHADOW/HOLD	This function will keep the gate in its fully open position while the signal is present. This is typically used with a loop and loop detector to keep a large swing gate open while vehicular traffic is passing through.
24VDC+ & 60	RUN/PRE-START	A 24Volt DC device such as a strobe light or alarm can be wired to these terminals. Depending on dip switch #2, these devices will either begin three seconds before the operator starts, or only while the motor is running. (See page 7 for details.)

 **You must follow all required safety precautions and instructions at all times. Review the safety brochure included with the operator. If any pages are missing or unreadable, contact OSCO at 1-800-333-1717 to request additional copies.**

 **Never connect a button station within reach of the gate or on the side of the gate operator.**

 **Do not adjust the circuit board current sensing feature too high. It should be adjusted high enough to keep the gate from falsely triggering the sensing, but no higher than necessary for the gate to operate. Do not defeat the purpose of this function!**



# VS-GSWG OPERATOR INSTALLATION GUIDE

## CURRENT SENSING ADJUSTMENTS

Because gates vary in construction and may have different force requirements in the open and close directions to move, the OSCO control board has separate Multi-turn potentiometers for adjusting in both directions independently. The adjustment should be set light enough to maintain minimal force (40 lbs.) should an obstruction occur, but high enough to keep the gate moving under normal conditions without interruption.

Prior to adjusting the operator current sensing functions, make sure the gate moves freely in both directions. A badly aligned or poorly maintained gate may cause false triggering of the current sensor. Refer to page 7 when following the instructions below. A factory adjustment tool has been supplied to make these adjustments easier. This tool has been taped to the control box for your convenience.

### CLOSE DIRECTION CURRENT SENSE ADJUSTMENT

When the gate operator leaves the factory, it has been preset for a relatively light gate function and will require additional adjustment. Begin by starting the gate going closed. If the operator stops and reverses, turn the close direction potentiometer (see page 7) one turn higher, press the **STOP** button, and try again. Repeat this process until the gate no longer causes false tripping of the current sensor. Note that each time the gate operator reverses, the **STOP** button must be pressed. Next, turn the close direction potentiometer lower slowly while the operator is running the gate closed until the gate operator stops and reverses again. From this point, turn the close direction potentiometer higher by 1 1/2 turns for all 115 Volt AC and 24 Volt DC operators, and by 3/4 of a turn higher for all 230 Volt AC operators. Additional fine adjustment by 1/4 turns may be necessary to eliminate false triggering.

### OPEN DIRECTION CURRENT SENSE ADJUSTMENT

Repeat the same process with the open direction potentiometer while running the gate in the open direction. Once this is done, run the gate through several complete cycles and make sure the gate does not false trip in either direction.

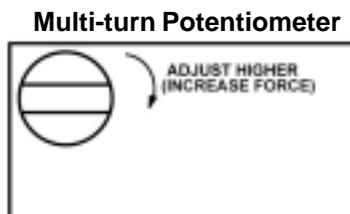

**Remember it is important not to set the adjustment too high! Doing so will defeat the purpose of the current sensing as an obstruction detecting feature.**

### MAXIMUM RUN TIMER ADJUSTMENT

This adjustable potentiometer sets the maximum length of time the motor will run before shutting down. It should be configured for the time it takes to run the gate fully open or closed, plus an additional 15 seconds. See page 7 for details.

### AUTO CLOSE TIMER ADJUSTMENT

This adjustable potentiometer sets the length of time which elapses before the gate operator automatically closes the gate, from the fully open position, provided no open, reversing, or obstruction signals are present. This feature can be turned on or off via dip switch selection. See page 7 for details. **Do not use the auto close timer without an appropriate reversing device installed!**

### MASTER/SLAVE CONNECTION

A three-wire shielded conductor cable is required to connect master and slave operators. You must use Belden 8760 Twisted Pair Shielded Cable (or equivalent) **only** – OSCO part number 2500-1982, per foot). See page 7 for details of this connection, as well as dip switch selection. Note: The SHIELD wire should be connected in both the master and slave operators. **In addition, you must run power to both the master and slave operators.**

# VS-GSWG OPERATOR INSTALLATION GUIDE

---

## ONBOARD L.E.D. INDICATOR DESCRIPTIONS

### Control Board L.E.D. Indicators:

- OPEN** This indicator is lit when an open signal is present. This signal can come from such devices as button stations, radio receivers, keypads and telephone entry systems.
- CLOSE** This indicator is lit when a closed signal is present. This signal typically comes from three-button stations.
- STOP** This indicator is lit when there is a break in the stop circuit. Make sure there is a stop button wired in and working properly.
- SINGLE** This indicator is lit when a signal from a single-button station or radio receiver is present.
- CLOSE OBST** This indicator is lit when a **close obstruction** signal is present. This signal can come from edges and photo eyes which have been wired to the close obstruction inputs.
- OPEN OBST** This indicator is lit when an **open obstruction** signal is present. This signal can come from edges and photo eyes which have been wired to the open obstruction inputs.
- SAFETY LOOP** This indicator is lit when a reversing signal is present. This signal is generated by a loop detector wired to the safety loop terminals.
- SHADOW LOOP** This indicator is lit when a shadow/hold open signal is present. This signal is generated by a loop detector wired to the shadow loop terminals.
- This indicator is lit when the open #1 limit switch is activated on a right-hand operator, or the close #1 switch on a left-hand. If this indicator is lit and the gate is not in its full open/closed position, the limit may need adjusting or the limit switch may need replacing.
- This indicator is lit when the open #2 limit switch is activated on a right-hand operator, or the close #2 switch on a left-hand.
- This indicator is lit when the close #1 limit switch is activated on a right-hand operator, or the open #1 on a left-hand. If this indicator is lit and the gate is not in its full open/closed position, the limit may need adjusting or the limit switch may need replacing.
- This indicator is lit when the close #2 limit switch is activated on a right-hand operator, or the open #2 switch on a left-hand.

### Motor Board L.E.D. Indicators:

- NON LABELED** One of these two indicators will be lit when the motor is running the gate open, and the other is lit when the motor is running the gate closed.
- BRAKE REL.** This indicator is lit when the brake is NOT applied.

# VS-GSWG OPERATOR INSTALLATION GUIDE

## IMPORTANT NOTES FOR INSTALLATION OF MASTER/SLAVE APPLICATIONS

When setting up Master/Slave gate operators, it is best to make adjustments and run each operator individually. To do this, simply:

- a. Set Dip Switch #4 to proper hand of operation (right-hand or left-hand)
- b. Set Dip Switch #8 as Master (off)

Run each operator making current sensing adjustments as necessary, as indicated on the Control Board Adjustments page of this installation guide. When both operators have been adjusted, turn power off, then turn on Dip Switch #8 in the operator chosen as the Slave.

The timer to close and radio/single button behavior are set in the Master operator.

The following selections are set individually:

- Current Sensing
- Maximum Run Timer
- One-Second Lock Release
- Three-Second Pre-Start Warning
- Right/Left-Hand Selections

## SURGE PROTECTOR INSTRUCTIONS

The optional surge protector should be connected to any inputs that have an accessory connected to it. This includes the 3-button station, so it must be connected to 1, 2A and 3 in all cases. The green wire connected to ground, which is electrically the same as terminal 4. The red wires connect to terminals 2A and 24VDC+. This will cause the 2 amp fuse to blow if this section of the module becomes shorted. With any of the other inputs connected to the surge protector, if their protection line becomes shorted due to a surge over the rating of the module, the corresponding LED on the main board will remain lit, causing a constant signal to the controller. If this is found, please replace the entire surge protector with a new unit.

**Do not simply unhook the shorted wire, as this removes the protection from the circuit that was saved by the protector in the first place!**

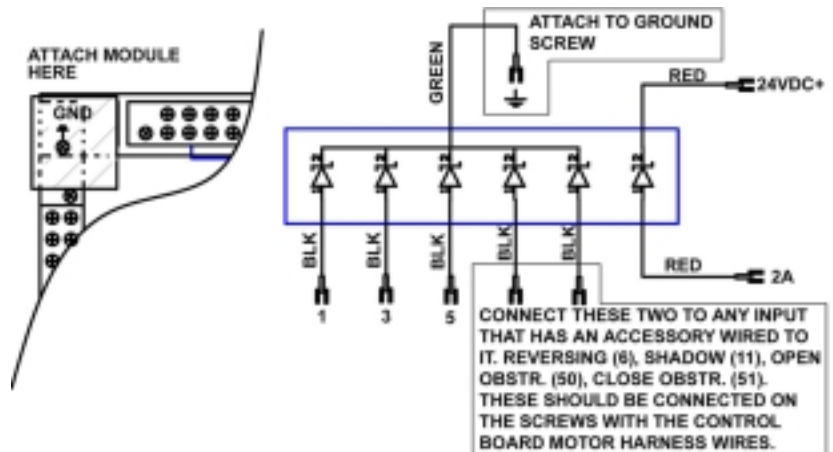

## ORDERING REPLACEMENT PARTS

Use the numbers shown in the lists on the following pages to order all replacement parts.

1. Supply the serial number of your operator.
2. Specify the quantity of pieces needed.
3. Order by part number and name of part.
4. State whether to ship by freight, truck, parcel post, UPS, or air express.
5. State whether transportation charges are to be prepaid or collect.
6. Specify name and address of person or company to whom parts are to be shipped.
7. Specify name and address of person or company to whom the invoice is to be sent.

# VS-GSWG OPERATOR INSTALLATION GUIDE

## CONTROL and ACCESSORY CONNECTION ILLUSTRATIONS

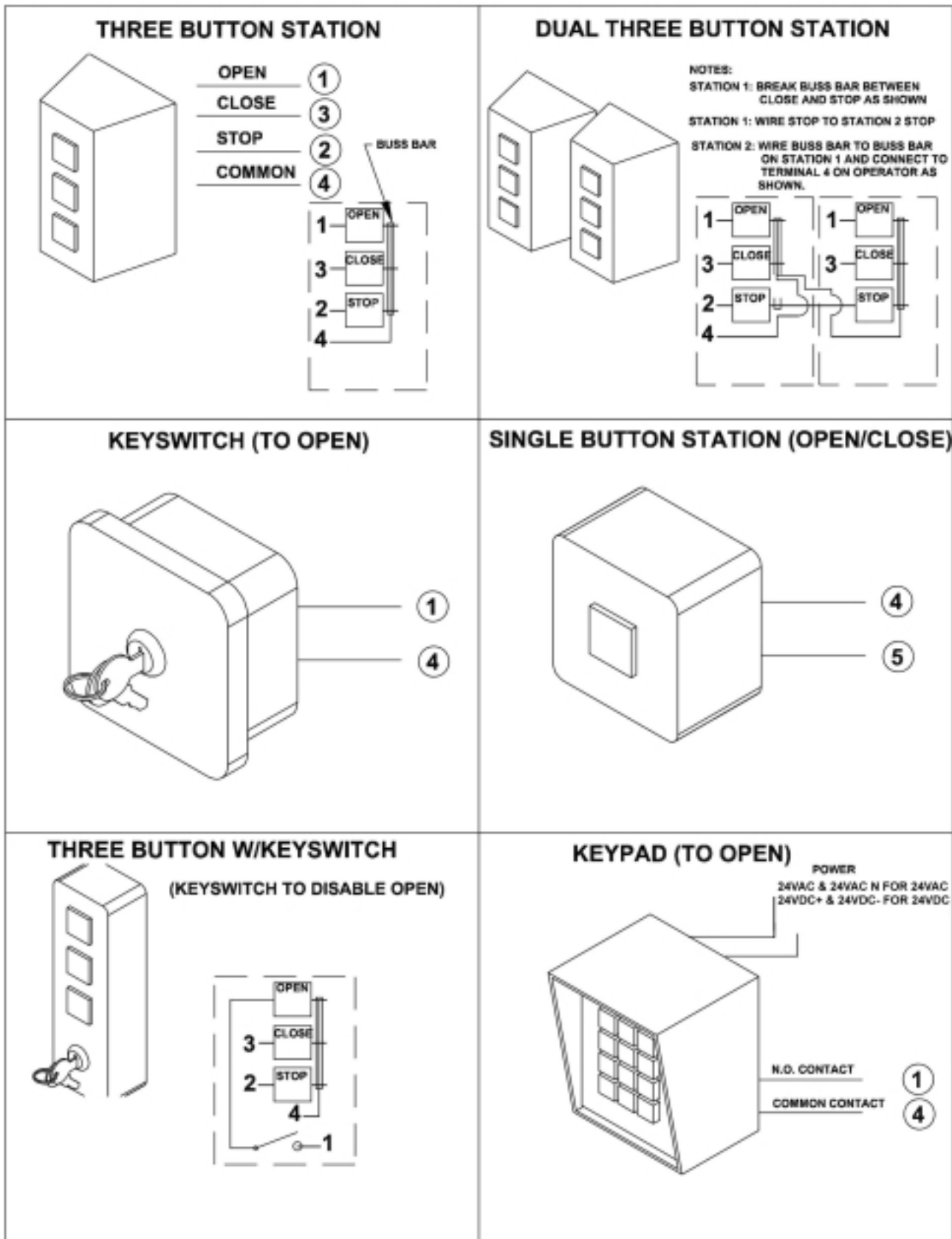

# VS-GSWG OPERATOR INSTALLATION GUIDE

## CONTROL and ACCESSORY CONNECTION ILLUSTRATIONS

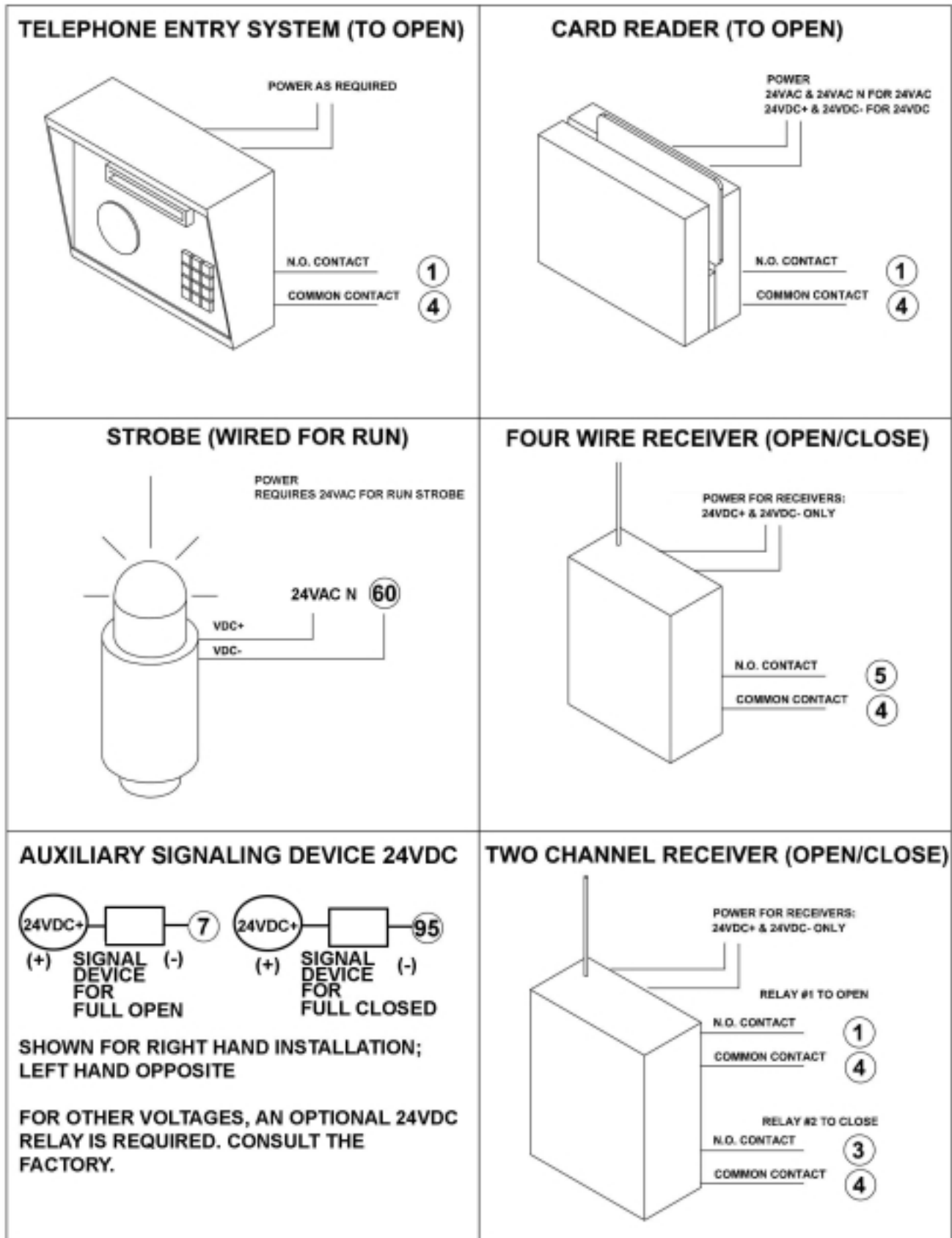

# VS-GSWG OPERATOR INSTALLATION GUIDE

## OSCO CONTROL and ACCESSORY CONNECTION ILLUSTRATIONS

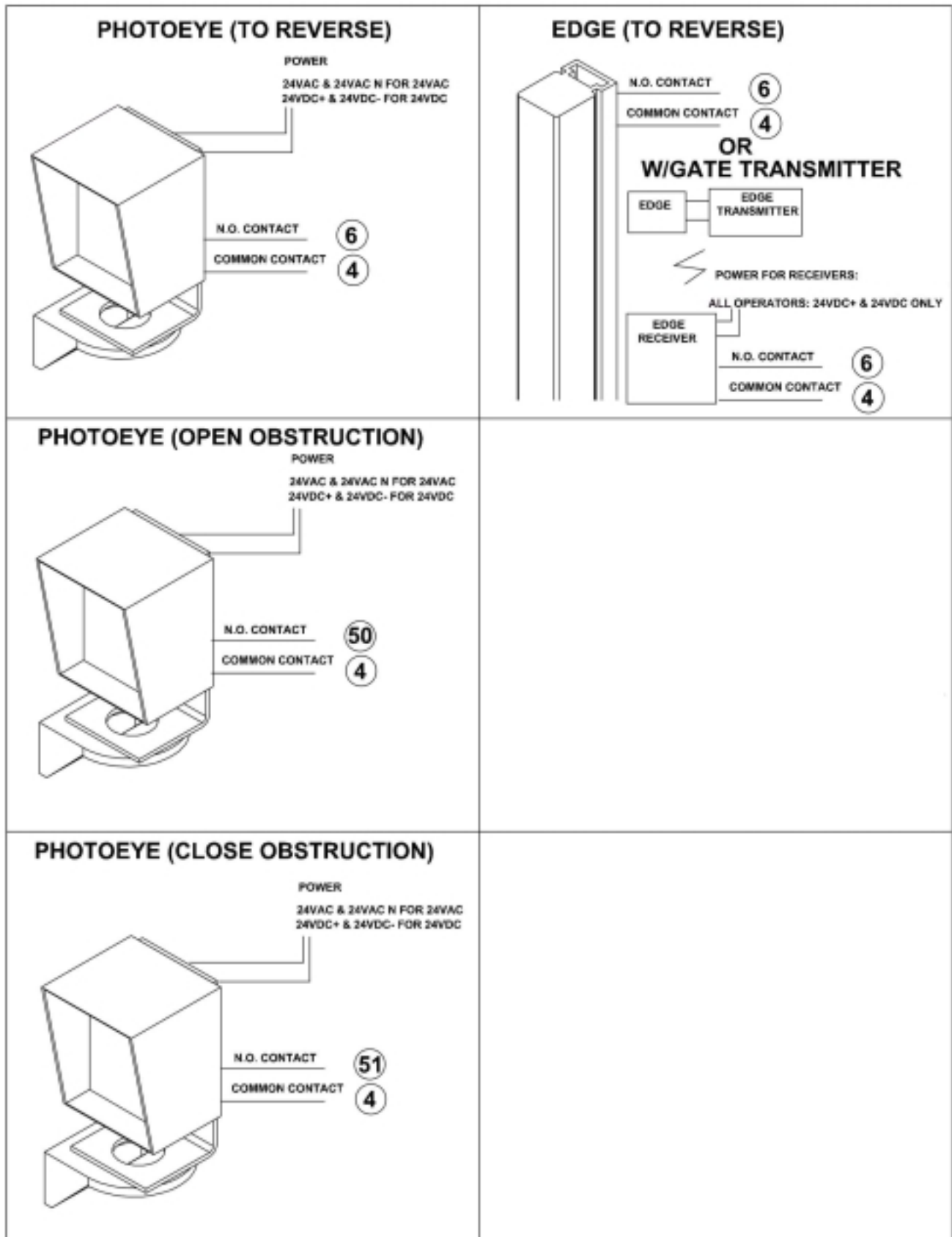

# VS-GSWG OPERATOR INSTALLATION GUIDE

## CONTROL and ACCESSORY CONNECTION ILLUSTRATIONS

<p><b>LOOP DETECTOR (OPEN/FREE EXIT)</b></p> <p>POWER 24VAC &amp; 24VAC N FOR 24VAC 24VDC+ &amp; 24VDC- FOR 24VDC</p> <p>N.O. CONTACT (1) COMMON CONTACT (4) TO LOOP REMEMBER TO TWIST LOOP WIRE</p>	<p>WIRES 17, 18, AND 19 ARE LOCATED IN THE MIDDLE OF THE J2 CONNECTOR</p> <p>J2 WIRES 17, 18, AND 19 FOR MAGLOCK AND SOLENOID CONNECTIONS</p>
<p><b>LOOP DETECTOR (TO REVERSE)</b></p> <p>POWER 24VAC &amp; 24VAC N FOR 24VAC 24VDC+ &amp; 24VDC- FOR 24VDC</p> <p>N.O. CONTACT (6) COMMON CONTACT (4) TO LOOP REMEMBER TO TWIST LOOP WIRE</p>	<p><b>SOLENOID LOCK</b></p> <p>SOLENOID (18) — POWER 2 (17) — POWER 1</p> <p>MAKE SURE TO MATCH POWER VOLTAGE TO LOCK RATING (17 &amp; 18 ARE NORMALLY OPEN CONTACTS, 10 AMP RATING)</p>
<p><b>LOOP DETECTOR (SHADOW/HOLD OPEN)</b></p> <p>POWER 24VAC &amp; 24VAC N FOR 24VAC 24VDC+ &amp; 24VDC- FOR 24VDC</p> <p>N.O. CONTACT (11) COMMON CONTACT (4) TO LOOP REMEMBER TO TWIST LOOP WIRE</p>	<p><b>24VDC MAGLOCK</b></p> <p>MAG LOCK + — (19) - — 24VDC- (17) — 24VDC+</p> <p><b>HEATER ASSEMBLIES (AC MODELS ONLY)</b></p> <p>STICK-ON HEATER LL2 L11</p> <p>LL2 ON OFF CAGE HEATER T'STAT THERMOSTAT L11 OR LL1 (3 PHASE MODELS ONLY)</p>

# VS-GSWG OPERATOR INSTALLATION GUIDE

## LOOP LAYOUT ILLUSTRATION

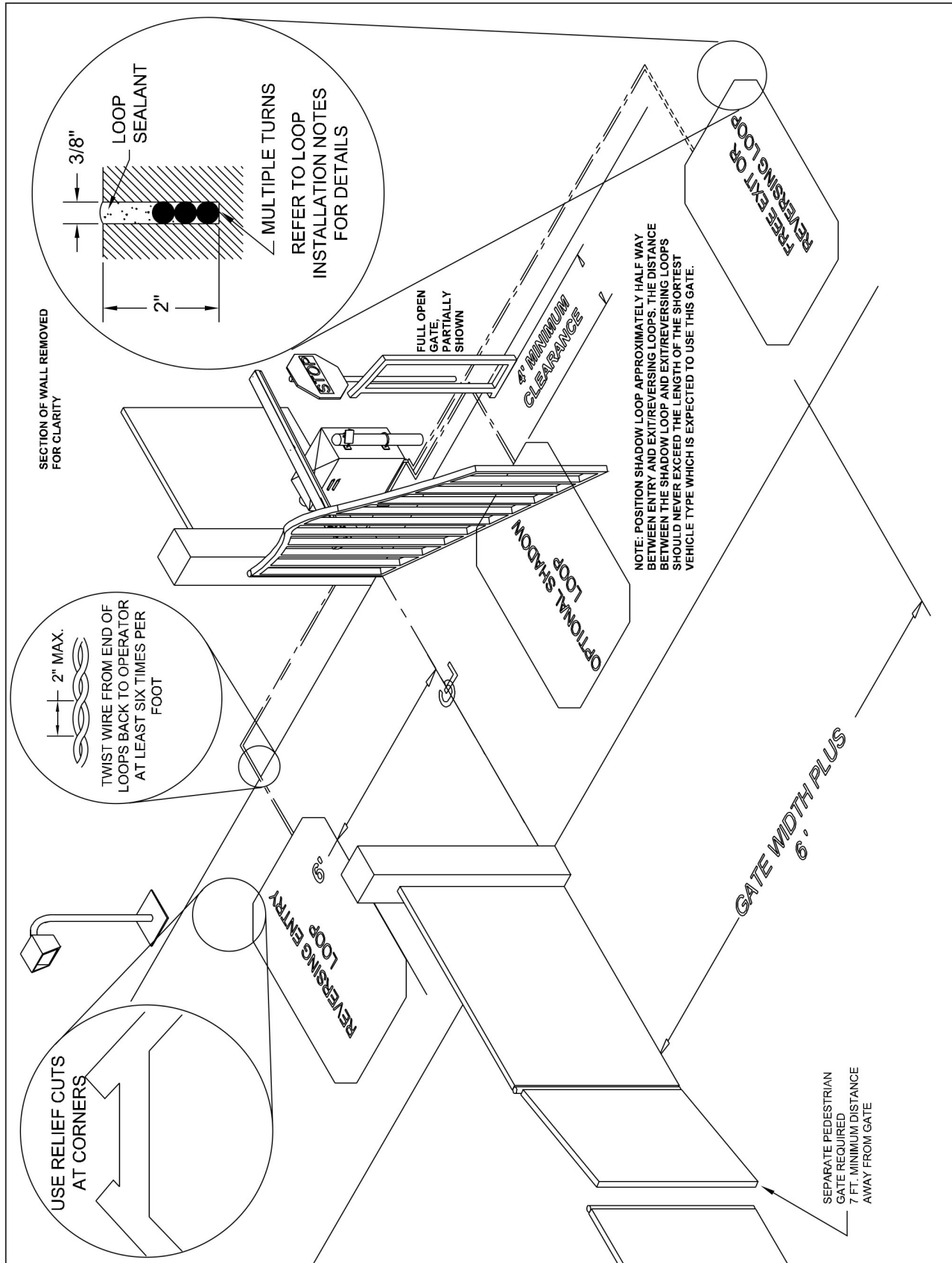

Refer to Connection Descriptions on page 8 and Loop Accessory Connections on page 15 for additional details.



# VS-GSWG OPERATOR INSTALLATION GUIDE

## EDGE LAYOUT ILLUSTRATION

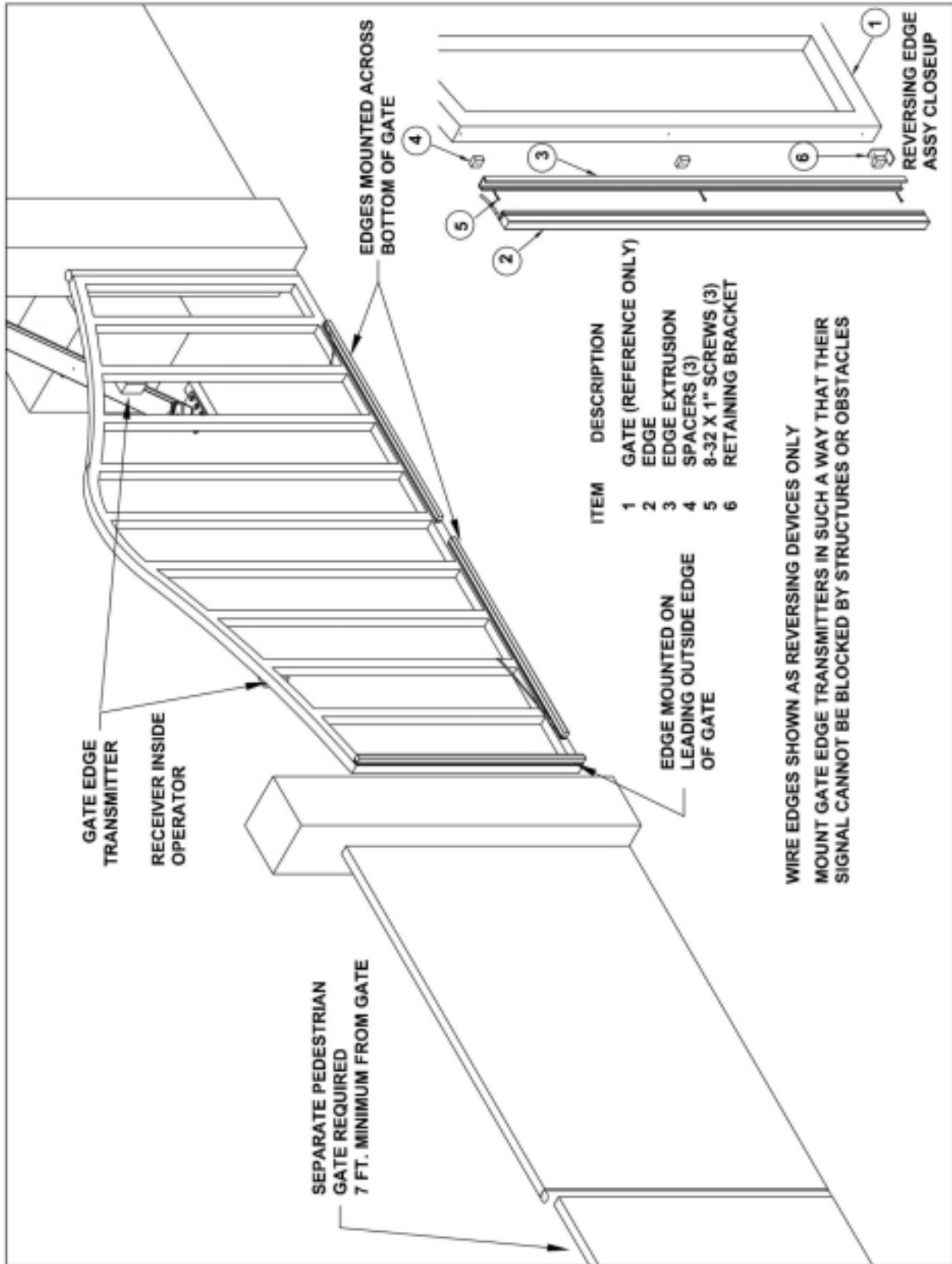

Refer to Connection Descriptions on page 8 and Contact Edge Connections on page 14 for additional details.

# VS-GSWG OPERATOR INSTALLATION GUIDE

## PHOTO EYE ILLUSTRATION

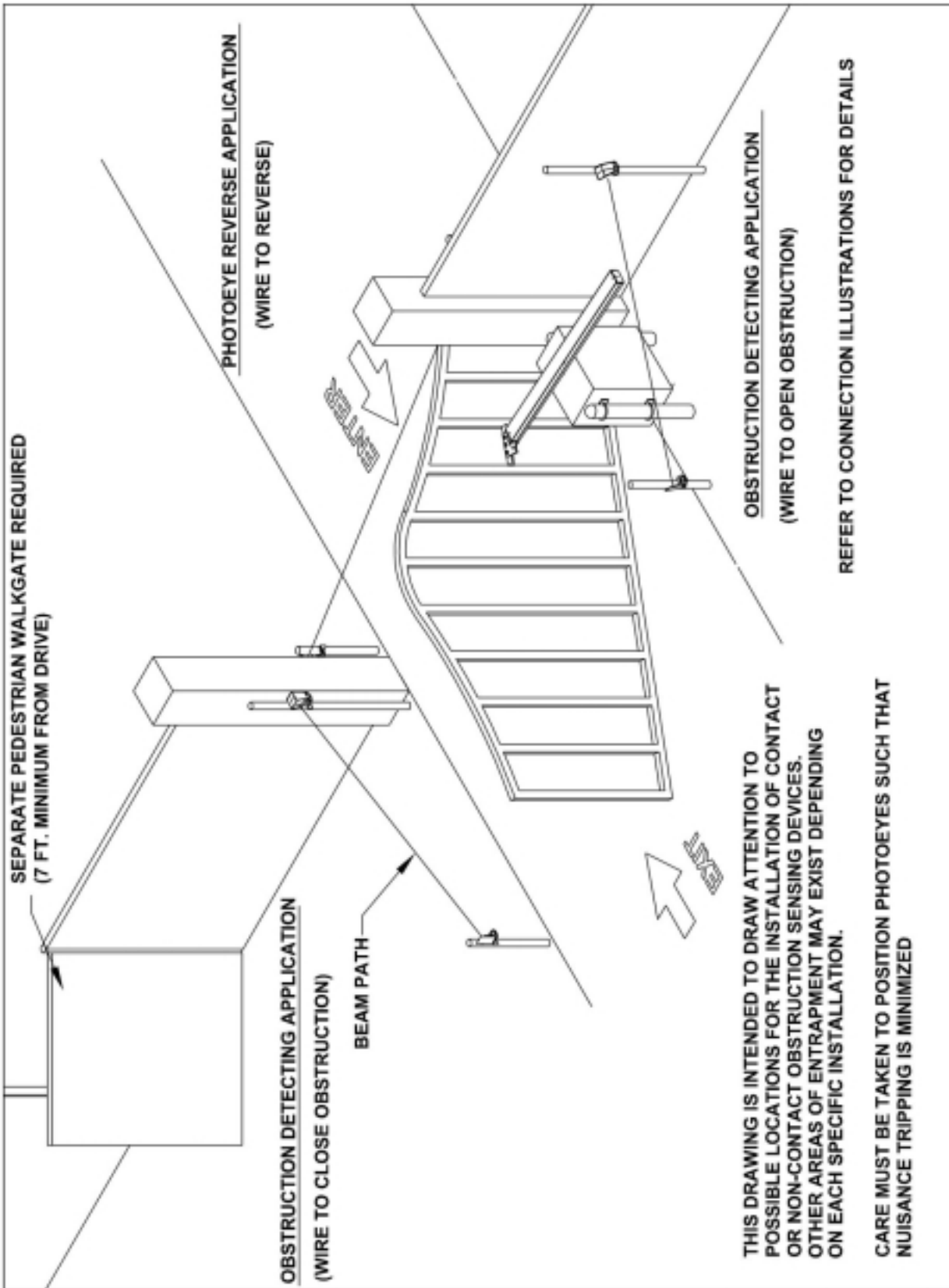

Refer to Connection Descriptions on page 8 and Contact Edge Connections on page 14 for additional details.

# VS-GSWG OPERATOR INSTALLATION GUIDE

## MODEL VS-GSWG MECHANICAL PARTS EXPLODED VIEW

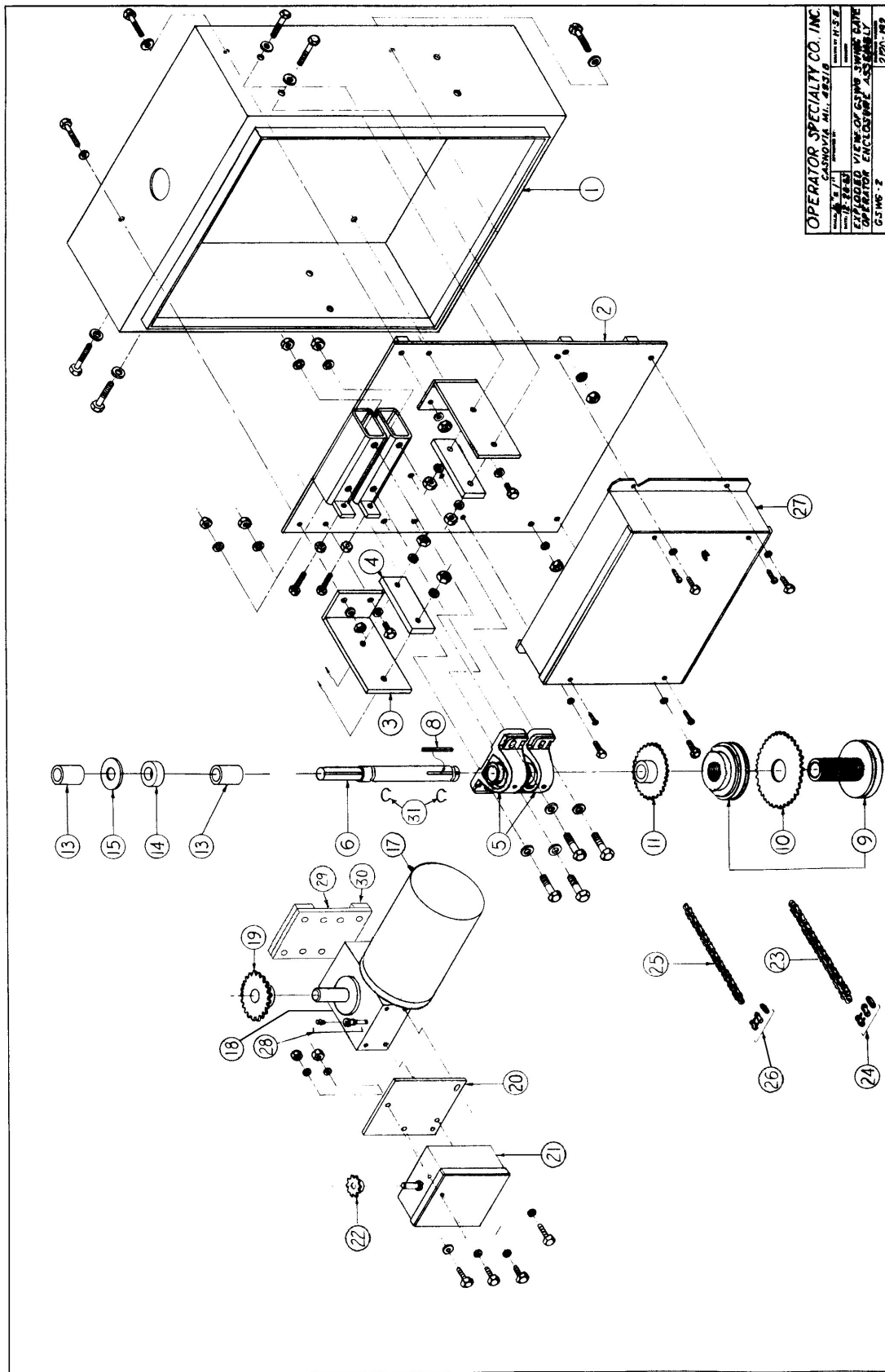

# VS-GSWG OPERATOR INSTALLATION GUIDE

## MODEL VS-GSWG MECHANICAL PARTS LIST

<u>Ref. No.</u>	<u>Part No.</u>	<u>Description</u>
1	2120-361	Complete Enclosure Assembly with Door
	2110-067	Enclosure Assembly without Door
	2120-362	Enclosure Door and Lock Assembly
	2110-643	Snap Lock Assembly only
2	2110-161	Mounting Panel Assembly
3	2100-708	Side Support Bracket
4	2100-656	Side Plate, 3/8"
5	2200-264	Pillow Block Bearing
6	2100-766	Drive Shaft, 1 1/8" diameter
8	2400-278	Key, 1/4" x 1/4" x 2 1/2"
9	2200-595	Torque Limiter, 5"
	2300-381	Torque Limiter Facing, 5"
10	2200-583	Sprocket, 40-A-36, 3" bore
11	2210-009	Sprocket, 48-B-30, 1 1/8" bore
13	2100-1112-PLT	Moisture Seal Spacer (2)
14	2200-016	Moisture Seal
15	2400-067	Seal Washer, 1" x 2 1/2"
18	2200-097	Gear Reducer, 60:1
19	2200-968	Sprocket, 40-B-22, 1" bore
20	2100-735	Limit Box Mounting Plate
21	2520-453	Rotary Limit Box Assembly
22	2200-008	Sprocket, 48-B-10, 1/2" bore
23	2200-459	#40 Roller Chain, 27 1/2 Links
24	2200-006	#40 Master Link
25	2200-200	#48 Roller Chain, 27 Links
26	2200-010	#48 Master Link
27		Complete Controller Assembly
28	2200-409	Pipe Nipple
29	2100-1414	Reducer Plate
30	2100-1413	Reducer Plate Spacer
	2200-428	Reducing Coupling
	2200-429	Pipe, 1/4" x 3 1/2" THD, both ends
	2400-264	Pipe Plug, 1/4"
	2510-064	Three-Button Station with Lead Wires
	2500-033	Three-Button Station only
	2400-514	Retaining Ring Clip
31		<b>C-Face Motors</b>
	2500-2313	1/2 HP, 208/230/460V, 3 Phase
	2500-2315	1 HP, 208/230/460V, 3 Phase
	2500-372	2 HP, 208/230/460V, 3 Phase

# VS-GSWG OPERATOR INSTALLATION GUIDE

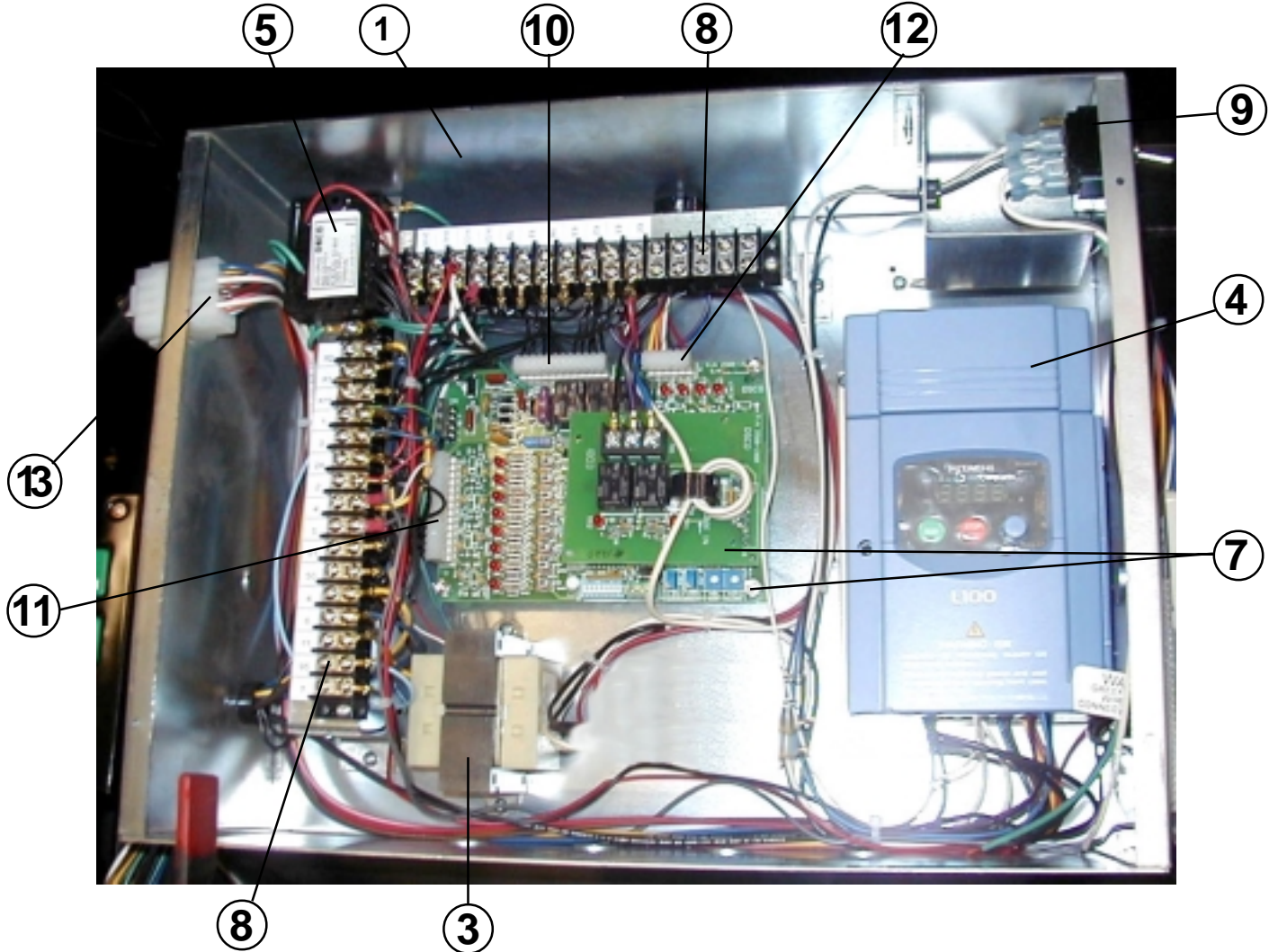

## MODEL VS-GSWG CONTROL BOX WITH HITACHI

REF. NO.	PART NO.	DESCRIPTION	REF. NO.	PART NO.	DESCRIPTION
<b>Variable Speed Control Box Assemblies</b>			<b>Hitachi Controllers continued</b>		
	2520-467	1/2 HP, 115V, 1-Phase Controller	4	2500-2247	1 HP, 208/230VAC, 1- or 3-Phase
	2520-468	1/2 HP, 208/230V, 1-Phase Controller		2500-2250	1 HP, 460VAC, 3-Phase
	2520-469	1/2 HP, 208/230V, 3-Phase Controller		2500-2248	2 HP, 208/230VAC, 1- or 3-Phase
	2520-470	1/2 HP, 460V, 3-Phase Controller		2500-2251	2 HP, 460VAC, 3-Phase
	2520-463	1 HP, 115V, 1-Phase Controller	5	2500-2207	Optional Low Voltage Surge Protector
	2520-464	1 HP, 208/230V, 1-Phase Controller	6	2500-1145	Potentiometer
	2520-465	1 HP, 208/230V, 3-Phase Controller	7	2510-295-VS	Control Board with 3-Phase Motor Board
	2520-466	1 HP, 460V, 3-Phase Controller		2510-268-VS	Control Board only
	2520-474	2 HP, 208/230V, 1-Phase Controller		2500-1980	3-Phase Motor Board (top board)
	2520-475	2 HP, 208/230V, 3-Phase Controller		2500-1975	3-Amp Fuse for Control Board
	2520-476	2 HP, 460V, 3-Phase Controller		2500-1966	2-Amp Fuse for Control Board
1	2120-079	Enclosure with Cover	8	2500-071	Terminal Strip, 16-141
3	<b>Transformers</b>		9	2500-2291	Power On/Off Switch, 30 Amp, 600VAC
	2500-766	115/24V, 75VA	10	2510-250	Output Wire Harness Assembly
	2500-767	208/230/24V, 75VA	11	2510-249	Input Wire Harness Assembly
	2500-768	460/24V, 75VA	12	2510-253	Limit Switch Harness
4	<b>Hitachi Controllers</b>		13	2510-346	Control Box Motor Harness, 115/230VAC
	2500-2244	1/2 HP, 115VAC, 1-Phase		2510-371	Control Box Motor Harness, 460VAC
	2500-2246	1/2 HP, 208/230VAC, 1- or 3-Phase			
	2500-2249	1/2 HP, 460VAC, 3-Phase			
	2500-2245	1 HP, 115VAC, 1-Phase			

# VS-GSWG OPERATOR INSTALLATION GUIDE

## PROGRAMMING INSTRUCTIONS FOR VARIABLE SPEED DRIVE WITH HITACHI

*This unit has been programmed at the factory.*

*No changes should be necessary for normal operation.*

**PLEASE CONSULT FACTORY BEFORE MAKING ANY CHANGES!**

- 1) Apply power
- 2) Press FUNC
- 3) Use ▲▼ arrows to advance to F—, (F002 for L200)
- 4) Press FUNC arrow to get to F02, (L100 ONLY)
- 5) Press FUNC, arrows to change to 3.0, (3.00 for L200) STR
- 6) Up arrow to advance to next parameter, (F03), FUNC to view, arrows to change, STR to store and continue, advance through listed parameters and store new values.
- 7) To switch from one letter prefix to another, press FUNC 3 times, advance to desired letter prefix, press FUNC, advance to desired parameter.

### MODEL L100

### MODEL L200

*List of parameters set at factory:*

Function	Description	Recommended Setting
F02	ACCEL TIME	3.0
F03	DECEL TIME	3.0
A01	SPEED SOURCE	00 (POT)
A02		01
A04	MAX SPEED	95.0 (Hz)
A20	TARGET SPEED	95.0
A21	SECOND SPEED	20.0
A62	MIN SPEED	20.0
B01	AUTO RESET	01
C03	TERM 3 FUNC	03
C04	TERM 4 FUNC	11

Function	Description	Recommended Setting
F002	ACCEL TIME	3.00
F003	DECEL TIME	3.00
A001	SPEED SOURCE	00 (POT)
A002		01
A004	MAX SPEED	95 (Hz)
A020	TARGET SPEED	95.0
A021	SECOND SPEED	20.0
A042	AUTO TORQUE BOOST	0
A044	BOOST PERCENT	00
A081	AUTO VOLTAGE REGULATION	01
A062	MIN SPEED	20.0
B001	AUTO RESET	01
B130	INHIBIT DECEL OVERVOLTAGE	01
C003	TERM 3 FUNC	03
C004	TERM 4 FUNC	11
C014	TERM 4 STATE	01

- 8) When all parameters have been changed, advance to D01, press FUNC, this will display operating speed in Hz. (0-95)

**NOTE:** L200 model must have these 2 switches in the DOWN position.

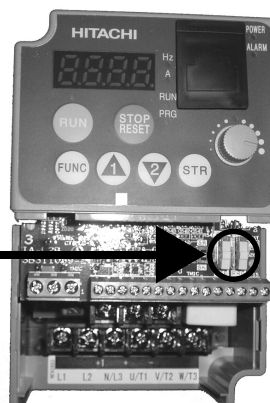



# VS-GSWG OPERATOR INSTALLATION GUIDE

## WIRING SPECIFICATIONS

- Select from the chart at the bottom of this page corresponding to the model, voltage and horsepower rating of your operator.
- The distance shown on the chart is measured in feet from the operator to the power source. **DO NOT EXCEED THE MAXIMUM DISTANCE.** These calculations have been based on standard 115V and 230V supplies with a 10% drop allowable. If your supply is under the standard rating, the runs listed may be longer than what your application will handle, and you should not run wire too near the upper end of the chart for the gauge of wire you are using.
- When large-gauge wire is used, a separate junction box (not supplied) may be needed for the operator power connection.
- All control devices are now 24VDC, which can be run considerable distances. 24VAC is available for other devices, such as loop detectors and photo eyes.
- Wire run calculations are based on the National Electrical Code, Article 430 and have been carefully determined based on motor inrush, brake solenoids, and operator requirements.
- Connect power in accordance with local codes. **The green ground wire must be properly connected.**
- Wire insulation must be suitable to the application.
- Control wiring must be run in a separate conduit from power wiring. Running them together may cause interference and faulty signals in some accessories.
- Electrical outlets are supplied in all 115VAC models for convenience with occasional use or low power consumption devices only. If you choose to run dedicated equipment from these devices, it will decrease the distance for maximum run and the charts will no longer be accurate.
- A three-wire shielded conductor cable is required to connect master and slave operators. You must use Belden 8760 Twisted Pair Shielded Cable (or equivalent) **only** – OSCO part number 2500-1982, per foot). See page 9 for details of this connection, as well as dip switch selection. **Note: The SHIELD wire should be connected in both the master and slave operators**

## USE COPPER WIRE ONLY!

### MODEL VS-GSWG – SINGLE PHASE

Power Wiring											
Volts & HP	Max Distance		Wire Gauge	Volts & HP	Max Distance		Wire Gauge	Volts & HP	Max Distance		Wire Gauge
	Single	Dual			Single	Dual			Single	Dual	
115V	222	111	12	208V	760	380	12	230V	894	447	12
	354	177	10		1200	600	10		1422	711	10
	566	283	8		1924	962	8		2264	1132	8
1/2 HP	900	450	6	1/2 HP	3060	1830	6	1/2 HP	3600	1800	6
	1430	715	4		4864	2432	4		5724	2862	4
115V	178	89	12	208	604	302	12	230V	710	355	12
	282	141	10		958	478	10		1128	564	10
	450	225	8		1526	763	8		1796	898	8
3/4 HP	716	358	6	3/4 HP	2424	1212	6	3/4 HP	2852	1426	6
	1140	570	4		3856	1928	4		4538	2269	4
115V	160	80	12	208V	544	272	12	230V	640	320	12
	254	127	10		864	432	10		1016	508	10
	406	203	8		1374	686	8		1616	808	8
	646	323	6		2184	1092	6		2570	1285	6
	1026	513	4		3476	1738	4		4090	2045	4

### ACCESSORY WIRING

All Models		
Volts	Maximum Distance (ft.)	Wire Gauge
24VAC	250	14
	350*	12
24VDC	0-2000	14

\*Over 350 ft. use DC power.

### MODEL VS-GSWG – THREE PHASE

Power Wiring: 3 Phase											
Volts & HP	Max Distance		Wire Gauge	Volts & HP	Max Distance		Wire Gauge	Volts & HP	Max Distance		Wire Gauge
	Single	Dual			Single	Dual			Single	Dual	
208V 1/2 HP	1142	571	12	230V 1/2 HP	1344	672	12	460V 1/2 HP	3841	1921	12
	1816	908	10		2137	1069	10		6106	3053	10
	2890	1445	8		3400	1700	8		9712	4856	8
208V 3/4 HP	920	460	12	230V 3/4 HP	1084	542	12	460V 3/4 HP	3279	1640	12
	1464	732	10		1723	862	10		5212	2606	10
	2330	1165	8		2741	1371	8		8291	4146	8
208V 1HP	714	357	12	230V 1HP	840	420	12	460V 1HP	2689	1345	12
	1136	568	10		1336	668	10		4274	2437	10
	1804	902	8		2124	1062	8		6798	3399	8



# VS-GSWG OPERATOR INSTALLATION GUIDE

## PREVENTATIVE MAINTENANCE

### IMPORTANT!

- Always disconnect power from operator before servicing.
- Keep clear of gate during operation.

### GENERAL:

OSCO gate operators are designed for many years of trouble-free operation and, under recommended operating conditions, will require only minimal maintenance. To ensure that your unit is ready for operation at all times--and to preclude serious damage or failure--inspect the unit systematically. Proper adjustments and lubrication should be made as recommended.

### LUBRICATION:

**Bearings.** For models which have pillow block style bearings with greaseable fittings, lubricate at least twice a year with a lithium complex based, petroleum oil NLGI 2 rated grease. Oilite and precision sealed bearings do not require additional lubrication.

**Motor.** Motors have sealed ball bearings and do not require further lubrication. If bearing noise develops after several years of operation, bearings should be replaced by a motor repair company, or the motor should be replaced if necessary.

**Drive Chain and Sprocket (slide gate models only).** The main drive chain and sprockets should be inspected for wear, cleaned, and wiped down with a lightly oiled rag every six months.

**Swing Gate Arm (swing gate models only).** Check all bolts for proper tension and tighten if necessary. Make sure the arm folds overextends itself slightly against the overtravel stop to reduce the chance that the gate can be backdriven open. Adjust the close limit slightly if additional travel is required. Lightly lubricate all pivot points with a light machine oil.

**Barrier Gate Arm (barrier gate models only).** Check all bolts for proper tension and tighten if necessary. If the arm has been warped or damaged, replace as necessary.

### ADDITIONAL SIX MONTH PREVENTATIVE MAINTENANCE:

1. For operators which utilize torque limiting clutches, check for proper tightness. If there appears to be dust from wear on the pads, inspect the pads and replace if necessary. If the clutch cannot be adjusted tightly enough to move the gate without slipping, the pads must be replaced.
2. For operators with V-belts, inspect for wear and replace as necessary. Check for proper tension and adjust if required. Check all pulley setscrews for tightness and tighten if necessary.
3. For operators with internal chain drives, inspect chain and sprockets for wear and replace if necessary. Check for proper tension and alignment, and adjust if required. Check all hub sprocket setscrews and tighten if required.
4. Check limit switches and limit actuators (cams, limit nuts, etc.) for wear and replace as required. In rotary limit switch assemblies, wipe the limit shaft clean and apply a light coating of dry lubricant.
5. For operators with magnetic brakes, check for proper adjustment. Brake disc must run free when the brake is engaged. For brake assemblies other than C-face style, the brake should be adjusted so that the solenoid plunger throw is between 3/8" to 1/2". Too much throw will damage the solenoid. **If the solenoid emits a loud buzzing sound when the motor is run, the brake must be adjusted.**
6. In operators which have a disconnect handle, inspect disconnect handle for proper function and lubricate if necessary. Use a lithium based grease on all moving parts.
7. Inspect all nuts and bolts for proper tightness and tighten as necessary.
8. Check all reversing devices for proper function. Inspect all contact edges for wear and replace if required. Check photo-eyes for proper alignment and function.
9. Check current sensing for proper adjustment when finished with inspection and maintenance.
10. Inspect the installation area. Are all the warning signs intact and visible? If they are missing or need replaced, contact OSCO. Be sure there are no control stations mounted within reach of the gate. Review safety literature with the customer and advise them to remove any such stations found.

**For slide and swing gate operators, you must inspect the gate for proper operation. The gate should move easily without binding through its entire travel. If the gate does bind, adjust or fix as required. Failure to keep the gate in good working condition will have adverse effects on the operator.**

Date Prepared: February 02, 1996  
 Supersedes: January 07, 1995  
 MSDS Number: 225570

Cette fiche signalétique est aussi disponible en français

## 1. PRODUCT INFORMATION

Product Identifier: ESSO GEAR OIL GX 80W-90  
 Application and Use: Premium quality multigrade extreme pressure gear oil for use in automotive applications including some manual transmissions.  
 Product Description: A lubricating oil consisting of a saturated and unsaturated hydrocarbons derived from paraffinic distillate, and additives.

## REGULATORY CLASSIFICATION

WHMIS: Not a controlled product  
 CEPA: CANADIAN ENVIRONMENTAL PROTECTION ACT  
 All components of this product are either on the Domestic Substances List (DSL) or are exempt.

## TRANSPORTATION OF DANGEROUS GOODS INFORMATION

Shipping Name: Petroleum Lubricating Oil  
 Class: Not regulated Packing Group: Not regulated  
 PIN Number: Not regulated Guide Number: 129  
 Please be aware that other regulations may apply.

## TELEPHONE NUMBERS

Emergency 24 hr. 519-339-2145  
 Technical Info. 800-268-3183

## MANUFACTURER/SUPPLIER

IMPERIAL OIL  
 Products Division  
 111 St. Clair Ave. West  
 Toronto, Ontario M5W 1K3  
 416-968-4111

## 2. REGULATED COMPONENTS

The following components are defined in accordance with subparagraph 13(a) (I) to (IV) or paragraph 14(a) of the Hazardous Products Act:

NAME	%	CAS #
Not applicable		

## 3. TYPICAL PHYSICAL & CHEMICAL PROPERTIES

Physical State: Liquid  
 Specific gravity: not available  
 Viscosity: 15.50 cSt at 100 deg. C  
 Vapour Density: not available  
 Boiling point: 229 to 600 deg. C  
 Evaporation rate: <0.1 (1=n-butylacetate)  
 Solubility in water: negligible  
 Freezing/Pour Point: -27 deg. C D97  
 Odour Threshold: not available  
 Vapour Pressure: <0.1 kPa at 20 deg. C  
 Density: 0.89 g/cc at 15 deg. C  
 Appearance/odour: Dark brown liquid, petroleum hydrocarbon odour.

## 4. HEALTH HAZARD INFORMATION

NATURE OF HAZARD:  
 INHALATION: Negligible hazard at normal temperatures (up to 38 deg. C). Elevated temperatures or mechanical action may form vapours, mists or fumes which may be irritating to the eyes, nose, throat and lungs. Avoid breathing vapours or mists.  
 EYE CONTACT: Slightly irritating, but will not injure eye tissue.  
 SKIN CONTACT: Low toxicity. Frequent or prolonged contact may irritate the skin.  
 INGESTION: Low toxicity.  
 ACUTE TOXICITY DATA: Based on animal testing data from similar materials and products, the acute toxicity of this product is expected to be:  
 Oral: LD50 > 5000 mg/kg (rat)  
 Dermal: LD50 > 3160 mg/kg (rabbit)  
 Inhalation: LC50 > 5000 mg/m3 (rat)  
 OCCUPATIONAL EXPOSURE LIMIT:  
 ACGIH recommends: For oil mists, 5 mg/m3. Local regulated limits may vary.

## 5. FIRST AID MEASURES

INHALATION: Vapour pressure of this material is low and as such inhalation under normal conditions is usually not a problem. If overexposed to oil mist, remove from further exposure. Administer artificial respiration if breathing has stopped. Keep at rest. Call for prompt medical attention.  
 EYE CONTACT: Flush eyes with large amounts of water until irritation subsides. If irritation persists, get medical attention.  
 SKIN CONTACT: Flush with large amounts of water. Use soap if available. Remove severely contaminated clothing (including shoes) and launder before reuse. If irritation persists, seek medical attention.  
 INGESTION: If swallowed, DO NOT induce vomiting. Keep at rest. Get prompt medical attention.

## 6. PREVENTIVE AND CORRECTIVE MEASURES

PERSONAL PROTECTION: The selection of personal protective equipment varies, depending upon conditions of use. In open systems where contact is likely, wear safety goggles, chemical-resistant overalls, and chemically impervious gloves. Where only incidental contact is likely, wear safety glasses with side shields. No other special precautions are necessary provided skin/eye contact is avoided. Where concentrations in air may exceed the occupational exposure limits given in Section 4 and where engineering, work practices or other means of exposure reduction are not adequate, approved respirators may be necessary to prevent overexposure by inhalation.  
 ENGINEERING CONTROLS: The use of local exhaust ventilation is recommended to control emissions near the source. Laboratory samples should be handled in a fumehood. Provide mechanical ventilation of confined spaces.

Esso Sheet 80W-90 082500

HANDLING, STORAGE AND SHIPPING: Keep containers closed. Handle and open containers with care. Store in a cool, well ventilated place away from incompatible materials. Do not handle or store near an open flame, sources of heat, or sources of ignition. Odorous and toxic fumes may form from the decomposition of this product if stored at temperatures in excess of 45 deg. C for extended periods of time or if heat sources in excess of 121 deg. C are used. Empty containers may contain product residue. Do not pressurize cut, heat, or weld empty containers. Do not reuse empty containers without commercial cleaning or reconditioning.

LAND SPILL: Eliminate source of ignition. Keep public away. Prevent additional discharge of material. If possible to do so without hazard. Prevent spills from entering sewers, watercourses or low areas. Contain spilled liquid with sand or earth. Recover by pumping or by using a suitable absorbent. Consult an expert of disposal or recover material. Ensure disposal in compliance with government requirements and ensure conformity to local disposal regulations. Notify the appropriate authorities immediately. Take all additional action necessary to prevent and remedy the adverse effects of the spill.

WATER SPILL: Remove from surface by skimming or with suitable absorbents. If allowed by local authorities and environmental agencies, sinking and/or suitable dispersants may be used in unconfined waters. Consult an expert on disposal of recovered material. Ensure disposal in compliance with government requirements and ensure conformity to local disposal regulations. Notify the appropriate authorities immediately. Take all additional action necessary to prevent and remedy the adverse effects of the spill.

## 7. FIRE AND EXPLOSION HAZARD

Flashpoint and method: 178 deg. C COC D92  
 Autoignition: NA Flammable Limits: LEL: NA UEL: NA

## GENERAL HAZARDS:

Low hazard; liquids may burn upon heating to temperatures at or above the flash point. Decomposes; flammable/toxic gases will form at elevated temperatures (thermal decomposition). Toxic gases will form upon combustion.

FIRE FIGHTING: Use water spray to cool fire exposed surfaces and to protect personnel. Shut off fuel to fire.

Use foam, dry chemical or water spray to extinguish fire. Respiratory and eye protection required for fire fighting personnel. Avoid spraying water directly into storage containers due to danger of boilover. A self-contained breathing apparatus (SCBA) should be used for all indoor fires and any significant outdoor fires. For small outdoor fires, which may easily be extinguished with a portable fire extinguisher, use of an SCBA may not be required.

HAZARDOUS COMBUSTION PRODUCTS: Smoke, carbon monoxide, carbon dioxide and traces of oxides of sulphur. Alkyl mercaptans and sulfides may also be released.

## 8. REACTIVITY DATA

STABILITY: This product is stable. Hazardous polymerization will not occur.  
 INCOMPATIBLE MATERIALS AND CONDITIONS TO AVOID: Strong oxidizing agents.  
 HAZARDOUS DECOMPOSITION: Smoke, carbon monoxide, carbon dioxide, oxides of sulphur and phosphorus. Alkyl mercaptans and sulfides may also be released.

## 9. NOTES

This MSDS has been revised in Section 3.

## 10. PREPARATION

Date Prepared: February 02, 1996  
 Prepared by: Lubricants & Specialties  
 IMPERIAL OIL  
 Products Division  
 111 St. Clair Ave., West  
 Toronto, Ontario MsW 1K3  
 800-268-3183

CAUTION: "The information contained herein relates only to this product or material and may not be valid when used in combination with any other product or material or in any process. If the product is not to be used for a purpose or under conditions which are normal or reasonably foreseeable, this information cannot be relied upon as complete or applicable. For greater certainty, uses other than those described in Section 1 must be reviewed with the supplier. The information contained herein is based on the information available at the indicated date of preparation. This MSDS is for the use of Imperial Oil. Customers and their employees and agents only. Any further distribution of this MSDS by Imperial Oil customer is prohibited without the written consent of Imperial Oil."

IMPERIAL OIL  
 Products Division

# ESSO GEAR OIL GX 80W-90

# VS-GSWG OPERATOR INSTALLATION GUIDE

---

This page intentionally left blank.

# VS-GSWG OPERATOR INSTALLATION GUIDE

## GATE OPERATOR INSTALLATION CHECKLIST

INSTALLER	CUSTOMER	
_____	_____	1. The gate has been checked to make sure it is level and moves freely in both directions.
_____	_____	2. Potential pinch areas have been guarded so as to be inaccessible <b>OR</b> have contact and/or non-contact obstruction sensing devices installed.
_____	_____	3. The installer has installed one or more contact or non-contact obstruction sensing devices.
_____	_____	4. The slide gate has been screened or secured from the bottom of the gate to a minimum of 48 inches above ground to prevent a 2 1/4-inch sphere from passing through the openings anywhere in the gate and in that portion of the adjacent fence that the gate covers when the gate is in the open and closed positions. Picket gates which have spacings less than 2 1/4 inches apart to the minimum height requirement are also acceptable.
_____	_____	5. Roller covers have been installed on cantilever gates.
_____	_____	6. If pedestrian traffic is expected, a separate pedestrian gate has been installed, a minimum of seven feet from the gate. The customer has been informed that <b>all pedestrian traffic must use the pedestrian gate.</b>
_____	_____	7. Warning signs have been installed on each side of the gate in highly visible locations. The customer has been informed that these signs must remain at all times.
_____	_____	8. There are no controls installed on the gate operator, or within seven feet of the gate.
_____	_____	9. The installer has instructed the customer in the proper use of the gate operator and reviewed all of the operational functions, obstruction sensing devices, warning beeper and reset, etc.
_____	_____	10. The installer has instructed the customer in the proper use of the operator's manual disconnect feature. The manual disconnect must never be used while the gate is in motion. The power switch must be turned off before using the manual disconnect and disengaging the operator.
_____	_____	11. The installer has reviewed all safety instructions with the customer, and has left the safety instructions and owner's information sheets for their reference.
_____	_____	12. The installer has answered any questions the customer has regarding the operation of the gate operator and gate operator safety precautions.
_____	_____	13. The installer has explained to the customer that a regular maintenance schedule for both the gate and the gate operator is recommended.

By signing this installation checklist, I/we hereby certify that each item listed and checked above has been covered by the installer and is clearly understood by the customer.

\_\_\_\_\_  
Customer Signature

\_\_\_\_\_  
Date

\_\_\_\_\_  
Installer Signature

\_\_\_\_\_  
Date