

# INSTALLATION INSTRUCTIONS FOR GTO/PRO SW-5100 and GTO/PRO SW-6100 AC Powered Swing Gate Operators



**WARNING!**



- **READ ALL INSTRUCTIONS COMPLETELY** before attempting installation and use; failure to do so may result in serious injury or death!
- **This unit must only be installed by an experienced technician!**
- **DANGER: HIGH VOLTAGE!** Contact with gate operator circuitry can cause serious injury or death! Operator power must be disconnected before servicing!
- **This gate operator produces a high level of force. Stay clear of the unit while it is operating and exercise caution at all times.**

*This product meets and exceeds the requirements of UL 325, the standard which regulates gate operator safety, as established and made effective March 1, 2000, by Underwriters Laboratories Inc.*

**DO NOT Install This Operator Without Safety Edges!**

© 2000 GTO, Inc.

3121 Hartsfield Road • Tallahassee, Florida 32303

Telephone (800) 543-GATE or (850) 575-0176 • Fax (850) 575-8912 • [www.gtoinc.com](http://www.gtoinc.com)

The GTO/PRO SW-5100 and SW-6100 automatic swing gate operators are intended for use with vehicular gates. The operators can be used in Class I, II, III, and IV applications.

### VEHICULAR GATE OPERATOR CLASS CATEGORIES

**Residential Vehicular Gate Operator-Class I:** A vehicular gate operator (or system) intended for use in a home of one-to-four single family dwelling, or a garage or parking area associated therewith.

**Commercial/General Access Vehicular Gate Operator-Class II:** A vehicular gate operator (or system) intended for use in a commercial location or building such as a multifamily housing unit (five or more single family units), hotel, garages, retail store, or other building servicing the general public.

**Industrial/Limited Access Vehicular Gate Operator-Class III:** A vehicular gate operator (or system) intended for use in an industrial location or building such as a factory or loading dock area or other locations not intended to service the general public.

**Restricted Access Vehicular Gate Operator-Class IV:** A vehicular gate operator (or system) intended for use in a guarded industrial location or building such as an airport security area or other restricted access locations not servicing the general public, in which unauthorized access is prevented via supervision by security personnel.

### Conversion Chart

#### *Converting Metric Units to English Equivalents*

<b>When You Know</b>	<b>Multiply By</b>	<b>To Find</b>	<b>Symbol</b>
centimeters	0.3937	inches	in. (or ")
meters	3.2808	feet	ft. (or')
kilograms	2.2046	pounds	lb. (or #)

#### *Converting English Units to Metric Equivalents*

<b>When You Know</b>	<b>Multiply By</b>	<b>To Find</b>	<b>Symbol</b>
inches	2.5400	centimeters	cm
feet	0.3048	meters	m
pounds	0.4535	kilograms	kg

#### *Temperature*

deg. Celsius	$(^{\circ}\text{C} \times 1.8) + 32$	deg. Fahrenheit	$^{\circ}\text{F}$
deg. Fahrenheit	$(^{\circ}\text{F} - 32) / 1.8$	deg. Celsius	$^{\circ}\text{C}$



# TABLE OF CONTENTS

Gate Operator Class Categories .....	Inside Cover
Metric Conversion Chart .....	Inside Cover
Safety Instructions for the GTO/PRO-SW-5100 and GTO/PRO SW-6100 Swing Gate Operators .....	1
GTO Foot Pedal Release .....	1
Important Safety Instructions for the System Designer .....	2
Important Safety Instructions for the Installer .....	2
Important Safety Instructions Specific to Secondary Means of Protection Against Entrapment .....	4
Important Safety Instructions for the Consumer/End User .....	5
Required Safety Precautions for Gates .....	6
Warning Labels .....	7
Technical Specifications .....	8
Parts Identification .....	9
Installing the Gate Operator .....	11
Preparation of the Gate .....	11
Operator Installation Overview .....	11
Using the Mounting Template .....	12
Removing the Operator Housing and Safety Covers .....	12
Mounting the Operator .....	13
Connecting the Gate Arm Assembly .....	14
Connecting Power to the Operator .....	14
Adjusting the Limit Switches .....	15
Advanced Gate Operator Control Board .....	16
Control Board Settings .....	17
Advanced Control Board Features .....	20
Setting Your Personal Transmitter Code .....	21
Mounting the Receiver .....	21
Installing Safety Covers on the Operator .....	22
Compatible Safety Devices .....	23
Installing a Dual Gate Operator System .....	24
Maintenance .....	27
Trouble Shooting Guide .....	28
Warranty and Repair Service .....	29
Installation Check List .....	Back Cover

# SAFETY INSTRUCTIONS FOR THE GTO/PRO SWING GATE OPERATORS

Because automatic gate operators produce high levels of force, all system designers, installers, and consumers have an obligation to know the potential hazards associated with improperly designed, installed, or maintained gate operator systems. **Keep in mind that the gate operator is just one component of the total gate operating system.** Each component must work in unison to provide the consumer with convenience, security, and safety.

This manual contains various safety precautions and warnings for the system designer, installer, and consumer. Because there are many possible applications of the gate operator, the safety precautions and warnings contained in this manual cannot be completely exhaustive in nature. They do, however, provide an overview of the safe design, installation, and use of this product. **CAREFULLY READ AND FOLLOW ALL SAFETY PRECAUTIONS, WARNINGS, AND INSTALLATION INSTRUCTIONS TO ENSURE THE SAFE SYSTEM DESIGN, INSTALLATION, AND USE OF THIS PRODUCT.**

The precautions and warnings in this manual are identified with these   warning symbols.

This  symbol identifies the conditions that can result in serious injury or death from electrical shock.

This  symbol identifies the conditions that can result in damage to the operator or its components, serious injury, or death.

**Because GTO automatic gate operators are *only part* of a total gate operating system, it is the responsibility of the designer, installer, and purchaser to ensure the total system is safe for its intended use. Bypassing safety devices or neglecting to use safety devices with the gate operator is NOT acceptable.**

## Use the GTO FOOT PEDAL RELEASE (Patented) to Manually Operate the Gate

 **CAUTION: NEVER attempt to operate the foot pedal while the gate is in motion. DO NOT operate the gate with a transmitter or other activation device while the foot pedal is in use.**

**NOTE:** If the gate is fully closed when the foot pedal release is activated, you *may* need to manually unlock the arm at the knuckle joint. Pull the gate arm as shown (*at right*) to begin opening the gate.

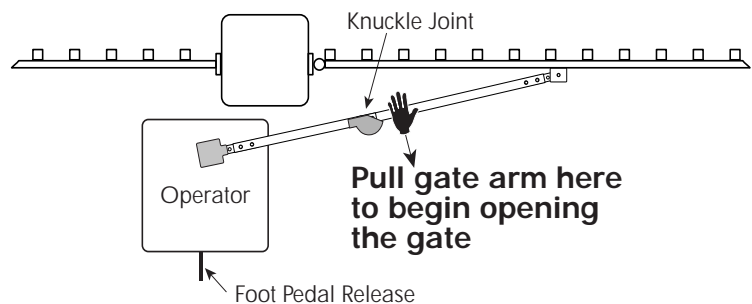

### **To disengage the operator:**

Place foot on pedal, then step down and push pedal to the **right** until it stops against the operator frame. Lift foot from pedal. This procedure disengages the lower spline from the upper spline and allows the gate to be opened and closed manually.

### **To re-engage the operator:**

*The limit switches will not have to be reset if this procedure is followed.*

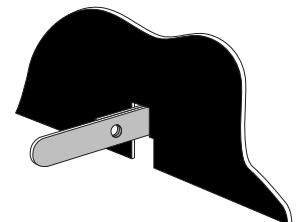

**You MUST return the gate to the position where the foot pedal release was engaged before activating the operator.** When the gate is stationary, place foot on pedal. Step down and push foot pedal to the **left** until it stops against operator frame. Lift foot from pedal. Move the gate back and forth until you hear the splines lock together. This procedure re-engages the lower and upper splines and allows the gate operator to drive the gate.



*The foot pedal release can be secured with a Master® pin lock (accessory available from your GTO dealer).*

# IMPORTANT SAFETY INSTRUCTIONS for the System Designer

## WARNING: To reduce the risk of injury or death:

1. **READ AND FOLLOW ALL INSTRUCTIONS.**
-  2. This operator is intended for use only on vehicular gates. Pedestrians must be supplied with a separate walk-through gate (*see **Entrapment Protection** illustration on page 6*).
3. When designing a system that will be entered from a highway or main thoroughfare, make sure the system is placed far enough from the road to prevent traffic congestion.
-  4. The gate must be installed in a location that ensures adequate clearance between it and adjacent structures when opening and closing to reduce the risk of entrapment. Swinging gates **shall not** open into public access areas.





# IMPORTANT SAFETY INSTRUCTIONS for the Installer

## WARNING—To reduce the risk of injury or death:

### I. Before Installation

1. **READ AND FOLLOW ALL INSTRUCTIONS.**
2. Verify this operator is proper for the type and size of gate, and its frequency of use.
3. Make sure that the gate has been properly installed and swings freely in both directions. Repair or replace all worn or damaged gate hardware prior to installation. A freely moving gate will require less force to operate and will enhance the performance of the operator and safety devices used with the system.
-  4. Review the operation of the system to become familiar with its safety features. Understand how to disengage and re-engage the operator foot pedal release (*see **GTO Foot Pedal Release** on page 1*).
5. This gate operator is intended for vehicular gates **ONLY**. A separate entrance or gate must be installed for pedestrian use (*see page 6*). **NO ONE SHOULD CROSS THE PATH OF A MOVING GATE.**

### II. During Installation

1. Install the gate operator on the inside of the property and fence line. **DO NOT** install an operator on the outside of the gate where the public has access to it. Swinging gates **shall not** open into public access areas.
-  2. Be careful with moving parts and avoid close proximity to areas where fingers or hands could be pinched. Make certain the pivot cover and knuckle cover are installed (*see pages 12 and 14*).
-  3. **Additional safety equipment such as safety covers and safety edges (or photoelectric sensors) MUST be installed to prevent bodily injury** (*see page 11*).
-  4. Determine the best obstruction sensing setting for this installation. The gate **MUST** stop and reverse on contact with an obstruction or when an object activates the non-contact sensors. After adjusting the force or the limit of travel, retest the gate operator. **Failure to adjust and retest the gate operator properly can increase the risk of injury or death.**
-  5. Mount access controls away from the gate (**minimum** distance is 10 feet). The user must have full view of the gate but be unable to touch it while operating the controls.
6. Secure outdoor or easily accessed gate operator controls in order to prohibit unauthorized use of the gate.

### III. After Installation

1. Review **ALL** safety instructions with the consumer/end user and explain the basic operation and safety systems of the entire gate operator system, including operation of the foot pedal release.
2. Inform the consumer/end user that servicing of the operator must only be done by an *experienced technician*.
3. Attach the **warning signs** (included) to each side of the gate to alert public of automatic gate operation. Take a photo of warning signs installed on gate. Record the date of the photo for your reference.
4. **SAVE THESE INSTRUCTIONS.**  
Leave **IMPORTANT SAFETY INSTRUCTIONS** manual (included) with consumer/end user.

# IMPORTANT SAFETY INSTRUCTIONS Specific to Secondary Means of Protection Against Entrapment

As specified by Underwriters Laboratories Inc. UL 325 (30A.1.1), automatic gate operators shall have *provisions for, or be supplied with*, at least one independent primary and one independent secondary means to protect against entrapment. GTO gate operators utilize **Type A**, an inherent entrapment sensing system, as the **primary** type of entrapment protection. The GTO/PRO SW-5100 and GTO/PRO SW-6100 operators have provisions for the connection of **Type B1, B2, or D** protection to be used as the **secondary** type of entrapment protection.

















1. For gate operators utilizing a non-contact sensor (Type B1) in accordance with UL 325 (51.8.4 [h]):
  - A. Refer to the sensor manufacturer's instructions on the placement of non-contact sensors for each type of application.
  - B. Care shall be exercised to reduce the risk of nuisance tripping, such as when a vehicle trips the sensor while the gate is still moving.
  - C. One or more non-contact sensors shall be located where the risk of entrapment or obstruction exists, such as the perimeter reachable by a moving gate or barrier.
2. For gate operators utilizing a contact sensor (Type B2) in accordance with UL 325 (51.8.4 [i]):
  - A. One or more contact sensors shall be located at the leading edge, bottom edge, and post mounted both inside and outside of a vehicular swing gate system.
  - B. A hard wired contact sensor shall be located and its wiring arranged so that the communication between the sensor and the gate operator is not subjected to mechanical damage.
  - C. A wireless contact sensor such as one that transmits radio frequency (RF) signals to the gate operator for entrapment protection functions shall be located where the transmission of the signals are not obstructed or impeded by building structures, natural landscaping or similar obstruction. A wireless contact sensor shall function under the intended end-use conditions.
3. For gate operators utilizing an actuating device requiring continuous pressure to maintain opening or closing motion of the gate (Type D) in accordance with UL 325 (51.8.4 [e]):
  - A. The gate operator controls must be placed so that the user has full view of the gate area when the gate is moving.
  - B. Warning signs (*see page 6*) shall be placed adjacent to the controls.
  - C. An automatic closing device (timer, loop sensor, etc.) shall not be employed.
  - D. No other activation device shall be connected.

## ENTRAPMENT ALARM (UL 325; 30A.1.1A)

The GTO/PRO SW-5100 and GTO/PRO SW-6100 operators are designed to stop and reverse for 2 seconds when the gate comes in contact with an obstruction or when an object activates the non-contact sensors. Additionally, these operators are equipped with an **audio entrapment alarm** which will function if the unit obstructs **twice** while opening or closing. This alarm will sound for a period of 5 minutes or until the operator receives an intended signal (e.g., transmitter signal) and the gate returns to a fully open or fully closed position.

# IMPORTANT SAFETY INSTRUCTIONS for the Consumer/End User

**WARNING: To reduce the risk of injury or death:**

-  1. **READ AND FOLLOW ALL INSTRUCTIONS.**
-  2. Distribute and discuss copies of the **IMPORTANT SAFETY INSTRUCTIONS** manual with all persons authorized to use your gate. **SAVE THESE INSTRUCTIONS.**
-  3. Always keep people and objects away from the gate and its area of travel. **NO ONE SHOULD CROSS THE PATH OF THE MOVING GATE.**
-  4. Your automatic gate is not for pedestrian use. If pedestrian traffic is expected near the gate, a walk-through gate must be installed for this purpose (*see page 6*).
-  5. Do not allow children or pets near your gate. **Never let children operate or play with gate controls.** Keep the remote controls away from children and unauthorized users; store controls where children and unauthorized users do not have access to them.
-  6. If push buttons or key switches are installed, they should be within sight of the gate, yet located far enough from it (at least 10 feet) so the gate cannot be touched while it is in operation. Do not operate any control without watching the movement of the gate.
-  7. Do not activate your gate operator unless you can see it and can determine that its area of travel is clear of people, pets, or other obstructions.
-  8. Verify that the pivot cover and knuckle cover have been installed on your operator to prevent hands and fingers from being pinched (*see page 6*). Make sure the knuckle cover warning decals (two) are affixed to the knuckle cover.
-  9. It is your responsibility to make sure that the installer posted warning signs on both sides of your gate. If any of these signs or warning decals become damaged, illegible or missing, replace them immediately. Contact your installer or GTO for replacements.
-  10. Verify that electric safety edge sensors (or photoelectric sensors) have been installed (*see page 6*). These safety devices should be tested monthly.
-  11. **KEEP GATES PROPERLY MAINTAINED.** Have a qualified service person make repairs to the gate hardware. **NEVER REMOVE THE OPERATOR HOUSING.**
-   12. **DANGER: HIGH VOLTAGE! Contact with gate operator circuitry can serious injury or death! DO NOT** attempt to service this operator yourself; for service, contact your installer or another experienced technician.
-  13. Have your gate operator tested monthly and serviced regularly by an experienced technician. The gate **MUST** stop and reverse on contact with an obstruction or when an object activates the non-contact sensors. If these functions are observed to operate improperly, discontinue use and have operator serviced immediately.
-  14. To operate this equipment safely, **YOU** must receive detailed instructions on the operation of the foot pedal release (*see GTO Foot Pedal Release on page 1*). If you feel you have not received full and proper instructions, contact your installer.
-  15. Use the foot pedal release **only** when the gate is not in motion. **DO NOT** operate the gate with a transmitter or other activation device while the foot pedal is in use.



# Required Safety Precautions for Gates

## Install Safety Edges, Warning Signs, and Safety Covers

**Safety edges** provide the gate operator with an integral safety feature by stopping and reversing gate direction upon sensing an obstruction. **Warning signs** alert people of automatic gate operation. **Safety covers** prevent hands and fingers from being pinched by the moving parts of the gate operator. All of these safety precautions are required when installing the GTO/PRO SW-5100 and GTO/PRO SW-6100 swing gate operators.

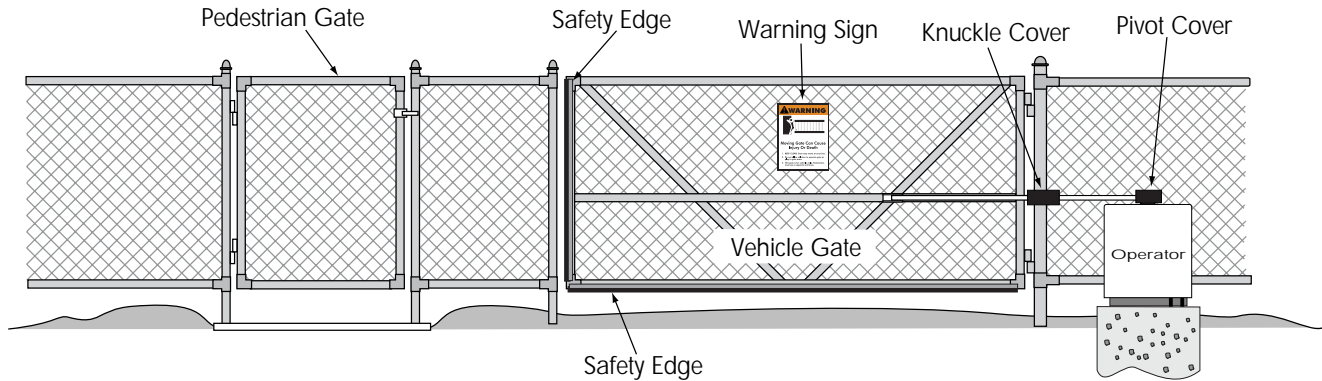

## Entrapment Protection

GTO's internal obstruction settings, even when properly adjusted, **may not be sensitive enough to prevent bodily injury**. For this reason, safety devices such as safety edges **MUST** be installed. Furthermore, a walk-through gate must be installed if pedestrian traffic is expected near the gate. We recommend the **GTO Bulldog Pedestrian Gate Lock** (available as an accessory) for controlled access.



## Warning Signs

The large warning signs (with orange panel) must be installed on both sides of the gate. The small warning signs (at right) must be installed adjacent to entry controls such as keypads and push buttons (see page 7 for details).

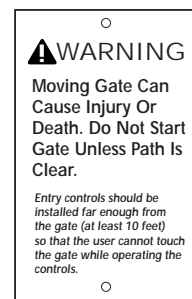

# Warning Labels

These warning signs and labels should be found at the locations specified below. If any of them are missing, immediately contact your installer for replacements.



warning label (1) installed on operator housing

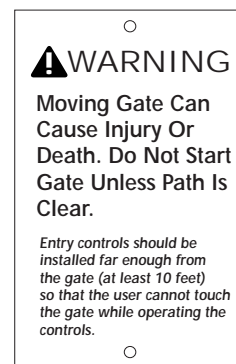

warning signs (2) to be placed adjacent to an entry control (such as a push button or keypad)



warning signs (2) installed on each side of the knuckle cover on the operator arm

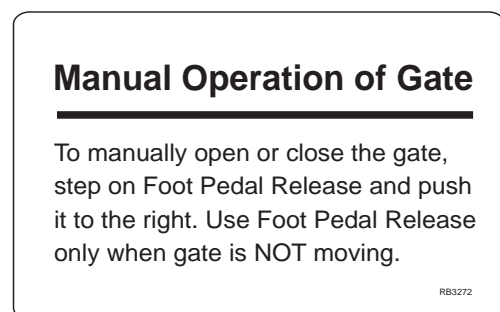

manual operation instruction label (1) installed on operator housing

# TECHNICAL SPECIFICATIONS

## for the GTO/PRO SW-5100 & SW-6100 AC Swing Gate Operators

### Motor

- GTO/PRO SW-5100: 1/2 hp GTO-Leeson 1625 rpm TEFC; C-Face connection; 115 V, three phase.
- GTO/PRO SW-6100: 1 hp GTO-Leeson 1600 rpm TEFC; C-Face connection; 115 V, three phase.

### Gear Reducer

- Totally enclosed 900:1, double reduction gear reducer, with vertical motor flange.
- Machine cut bronze gears run in an oil bath.
- Oil temperature range: -22 °F to 806 °F (-30 °C to 430 °C).

### Power

- GTO/PRO SW-5100: 115 Vac, 60 Hz, 5 A; GTO/PRO SW-6100: 115 Vac, 60 Hz, 9.8 A.
- Requires *copper conductors*.
- Must be installed by an electrician in accordance to NEC (National Electric Code) and local codes.
- Product relies on a 15 A main disconnect circuit breaker (supplied by the installer).
- One 115 Vac dual GFCI outlet (located below control box) for additional accessories.
- Two 12 V back-up batteries provide up to 200 gate cycles in the event of a power failure

### Control

- Adjustable auto-close timer: 1 – 120 seconds.
- Independent obstruction settings for opening and closing cycles.
- Diagnostic and error condition LEDs.
- Potentiometers and DIP switches for easy adjustments.
- Six separate terminals for N/O contacts (e.g., safety edges or photoelectric beams).
- Mechanical limit controls.
- GTO remote mounted RF receiver tuned to 318 MHz (other receivers can be accommodated).
- Inverter provides soft start/soft stop gate movement and control battery back-up feature.

### Construction

- Zinc plated steel parts for maximum corrosion resistance.
- Mounting brackets can be welded or bolted.
- Lockable foot pedal release (patented) allows manual operation of gate.

### Operational Capacity

- Operator compatible with all types of horizontal swing gates / with a maximum opening of 90 degrees
- GTO/PRO SW-5100: maximum weight 1500 lb.; maximum length 20 ft.
- GTO/PRO SW-6100: maximum weight 2500 lb.; maximum length 20 ft.
- Duty Cycle: Continuous.

### Dimensions

- Housing: Width 24 in.; Depth 25.5 in.; Height 29.5 in.
- Control Box: Width 14 in.; Depth 6 in.; Height 16 in.
- Shipping Weight: GTO/PRO SW-5100 321 lb.; GTO/PRO SW-6100 327 lb.

# PARTS IDENTIFICATION

## GTO/PRO SW-5100 and GTO/PRO SW-6100 AC Powered Swing Gate Operators

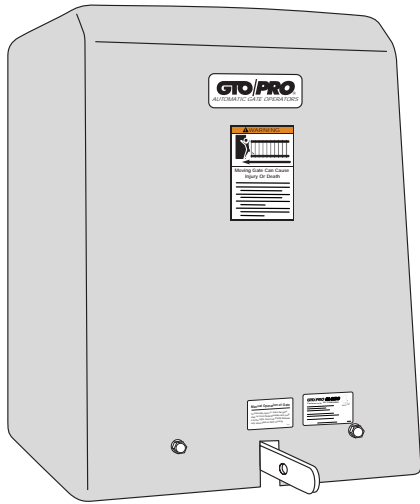

Fully Assembled Operator

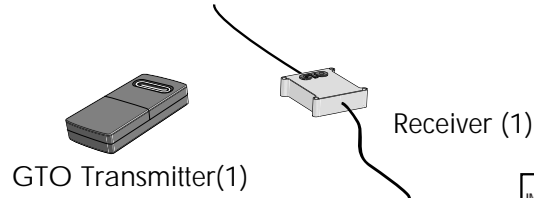

GTO Transmitter(1)

Receiver (1)



Entry Control  
Warning Signs (2)

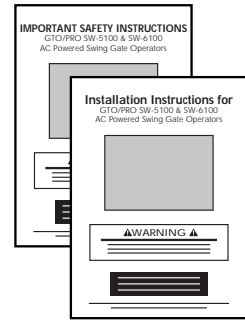

Installation & Safety  
Manual  
(1 each)

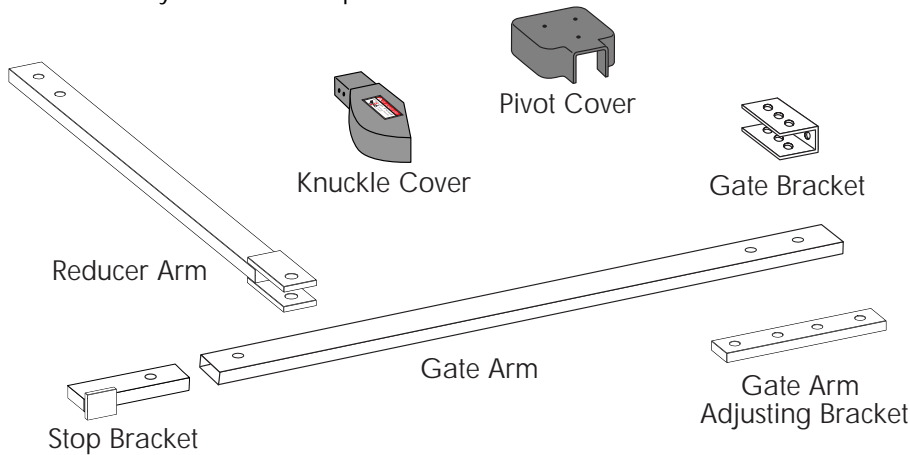

Reducer Arm

Knuckle Cover

Pivot Cover

Gate Bracket

Gate Arm

Gate Arm  
Adjusting Bracket

Stop Bracket



Gate Warning Signs  
(one for each side)

### Hardware

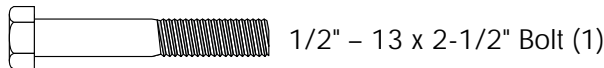

1/2" – 13 x 2-1/2" Bolt (1)

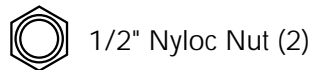

1/2" Nyloc Nut (2)



1/2" – 13 x 2" Bolt (1)

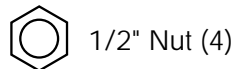

1/2" Nut (4)

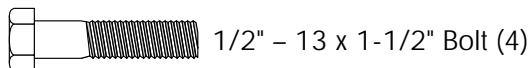

1/2" – 13 x 1-1/2" Bolt (4)

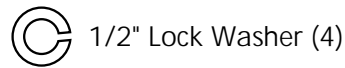

1/2" Lock Washer (4)

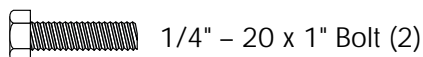

1/4" – 20 x 1" Bolt (2)

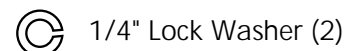

1/4" Lock Washer (2)



Ty Wraps (8)

# Parts Identification ...continued

## GTO/PRO SW-5100 and GTO/PRO SW-6100 AC Powered Swing Gate Operators

### Exploded View

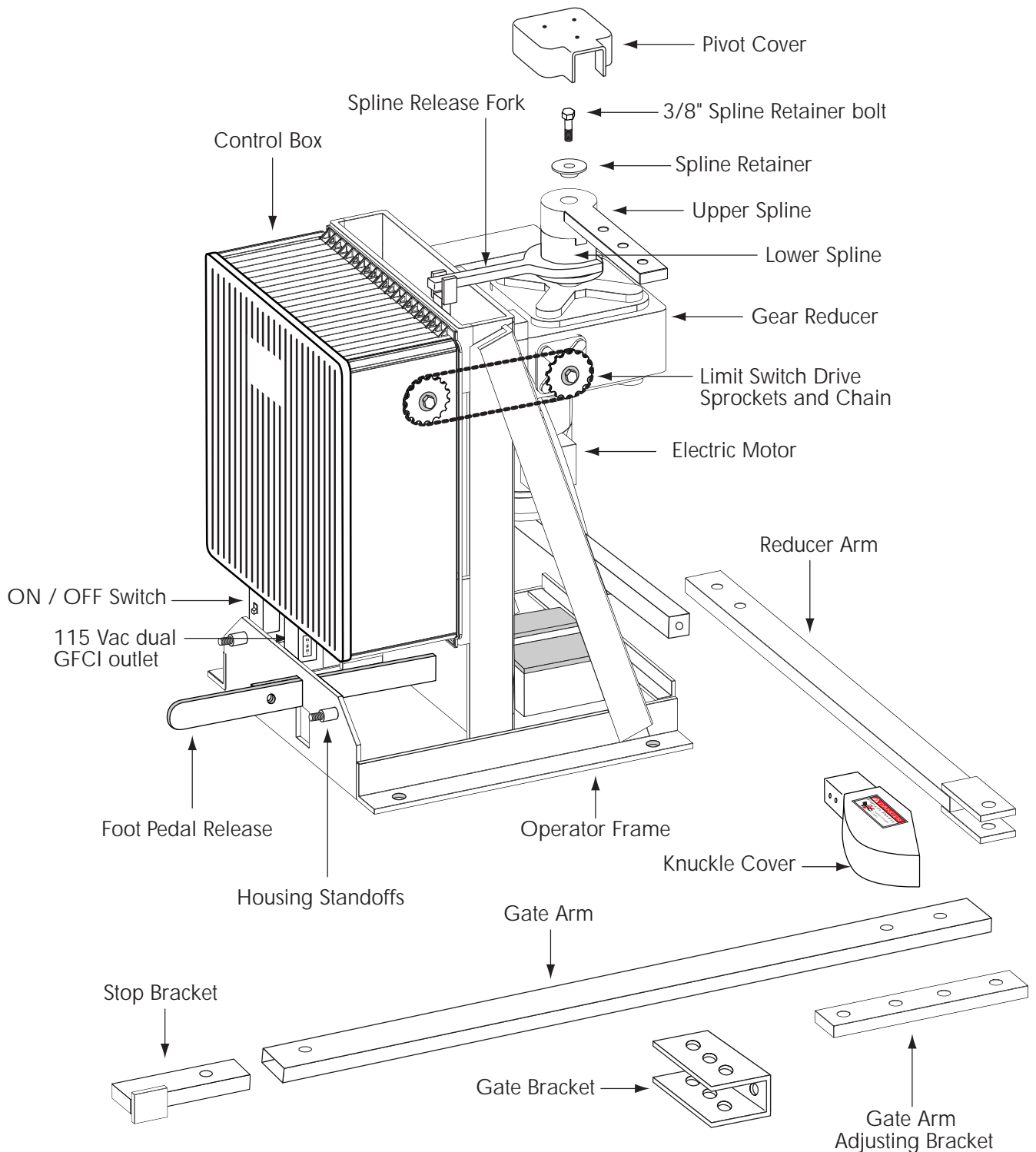

# INSTALLING THE GATE OPERATOR

THIS UNIT MUST ONLY BE INSTALLED BY AN EXPERIENCED TECHNICIAN.

## Preparation of the Gate

Before installing the GTO/PRO swing gate operator, make sure:

- the gate is properly installed.
- the gate is plumb, level, and moves freely.
- the gate does not bind or drag on the ground.

## Operator Installation Overview

The diagram below is an example of a single swing gate installation with required safety features. The operator must be installed on the **inside** of the gate. **You must install safety edges or photoelectric sensors (not included) and safety covers to reduce the possibility of bodily injury.**

**NOTE:** *A separate gate or entrance must be installed for pedestrian use.*

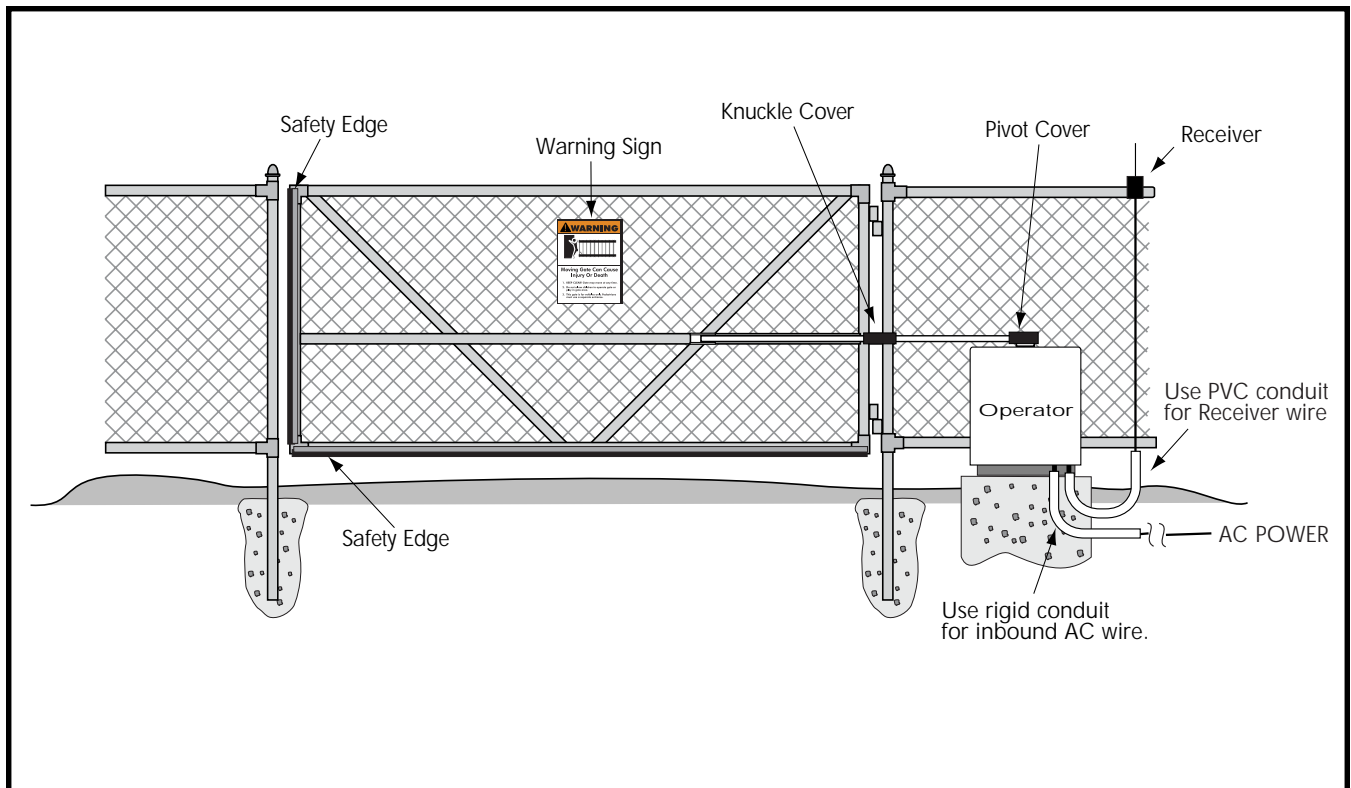

# Using the Mounting Template

The mounting template (*see insert*) is designed to simplify mounting the operator. It provides the installer with the proper locations for running power and accessory wiring conduits. The template is also marked with the correct distance between the operator mounting holes and shows the installer how to position the operator for the correct clearance between the housing and the gate.

**NOTE:** The operator must be securely mounted on a **level concrete pad**. If you do not have an existing pad to work with, be sure to install wiring conduit before pouring concrete. You must use (4) 1/2" diameter mounting anchors, washers, and nuts (*not included*) to mount the operator on the pad.

Study the mounting template. Lay the mounting template on the level concrete pad (the *maximum* distance from operator to gate hinge is 2 feet) and mark the pad according to the instructions on the template.

Before you attempt to mount the operator, check the following:

- The concrete pad is level.
- Four (4) 1/2" diameter mounting anchors are in their correct positions.
- Conduit for power and accessory wiring is installed.

# Removing the Operator Housing and Safety Covers

Before you can gain access to the operator frame and its mounting holes, the safety covers and housing will have to be removed from the operator.

1. Remove the (3) 1/4" x 1" bolts from the pivot cover. Remove the cover from the upper spline.
2. Remove the 3/8" bolt from the spline retainer. Remove the spline retainer and slip the upper spline off the output shaft of the gear reducer. Set these parts aside until you are ready to connect the gate arm assembly.
3. Remove the (2) 3/8" chrome acorn nuts and (2) 3/8" washers from the operator housing (this hardware is located on the front of the housing). Lift the housing off the operator and set it aside.

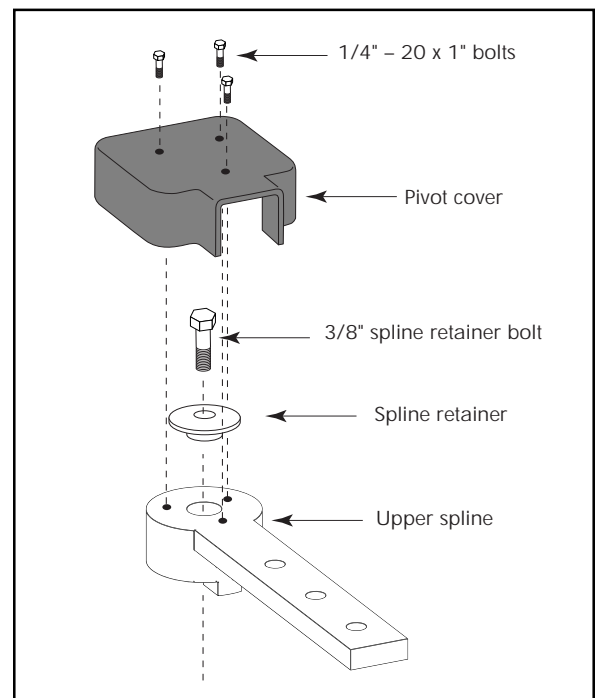
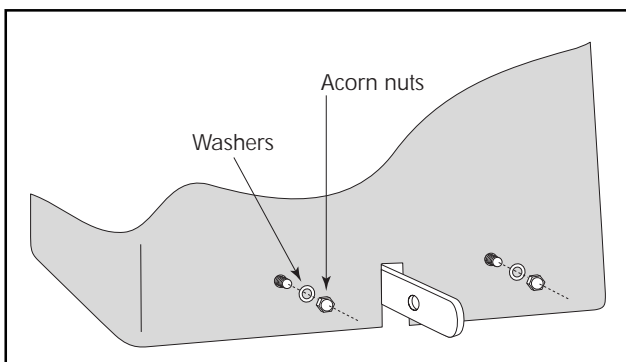

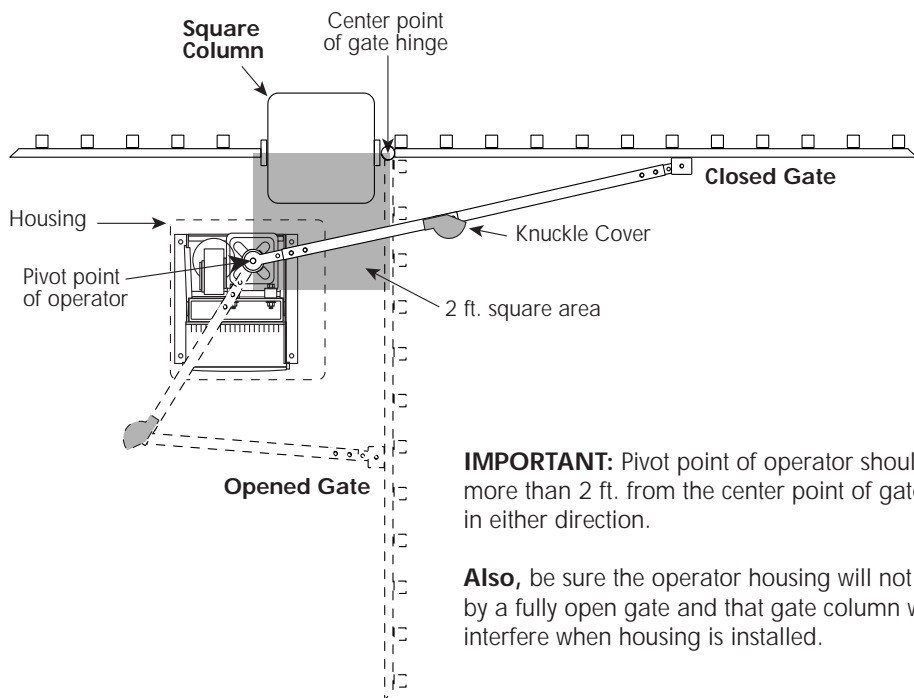

**IMPORTANT:** Pivot point of operator should be no more than 2 ft. from the center point of gate hinge in either direction.

**Also,** be sure the operator housing will not be hit by a fully open gate and that gate column will not interfere when housing is installed.

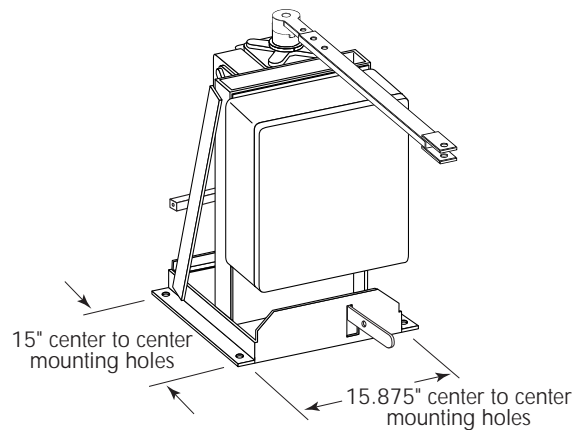
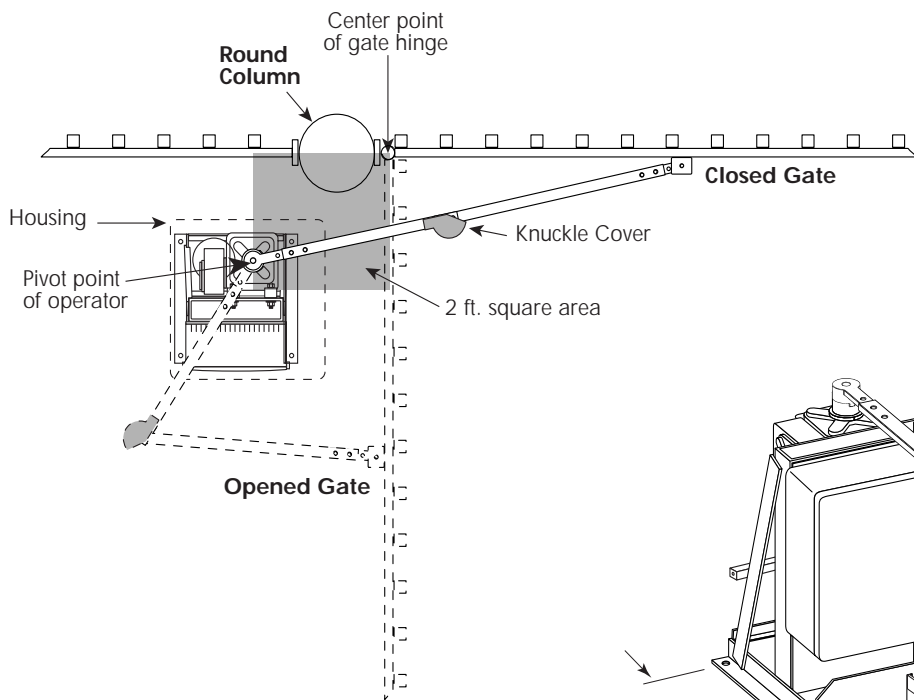

## Mounting the Operator

1. Lift the operator and align its mounting holes over the  $\frac{1}{2}$ " diameter concrete mounting anchors. Lower the operator into position and fasten it to the mounting anchors with (4)  $\frac{1}{2}$ " washers and nuts (*not provided*).
2. Reattach the upper spline to the output shaft of the gear reducer. Place the spline retainer on top of the upper spline and fasten it with the  $\frac{3}{8}$ " spline retainer bolt.
3. Step down on foot pedal to disengage the lower and upper splines (*see illustrations on page 1 and 10*).



# Connecting the Gate Arm Assembly

1. Fit the end of the reducer arm on the end of the upper spline (see illustration at right). Align the bolt holes of the parts and join them with (1) 1/2" bolt.
2. Fit the ends of the reducer arm and gate arm together (see illustration). Align the bolt holes of the parts and join them with (1) 1/2" bolt and (1) Nyloc nut.

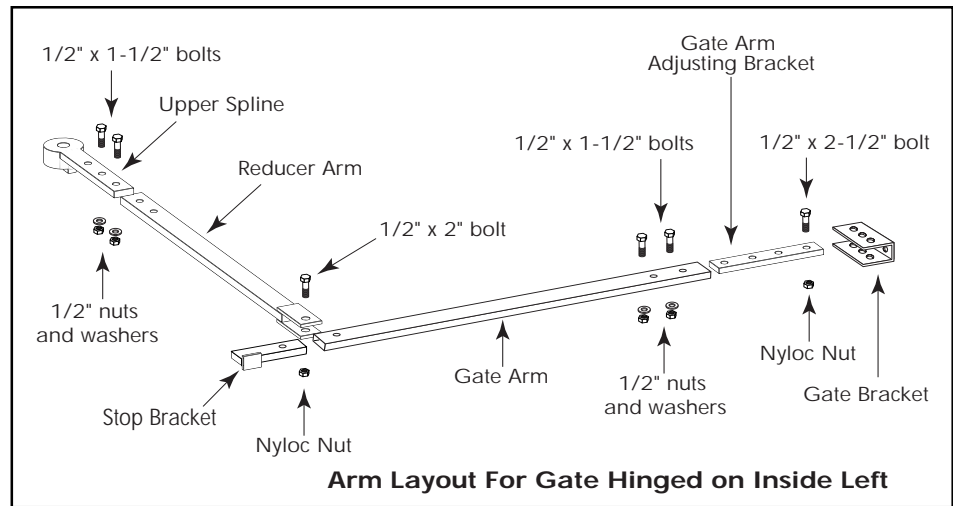

**⚠ To prevent hands and fingers from being pinched, fasten the knuckle cover over the knuckle joint of the gate arm with (2) 1/2" x 1" bolts.** NOTE: Make sure warning decals (2) are affixed to the knuckle cover.

3. Attach the adjusting bracket to the gate arm with (2) 1/2" bolts, nuts, and washers.
4. Attach the gate bracket to the end of the adjusting bracket with (1) 1/2" bolt and (1) Nyloc nut.
5. Swing the gate to its fully closed position. Pivot the gate arm assembly toward the gate until it is fully extended. **Make sure that the gate arm assembly is level.** Using the height of the *level* gate arm assembly as a reference, clamp a support bar (*not provided*) for the gate bracket to the gate.
6. Attach the gate bracket to the support bar with (2) 1/2" bolts, lock washers, and nuts (*not provided*).
7. Swing the gate through its full operating arc to verify that the gate arm retracts and extends without binding. Opening and closing the gate in this manner will also test the clearance between the gate and the operator.
8. Permanently bolt or weld the support bar to the gate once its correct position has been determined.

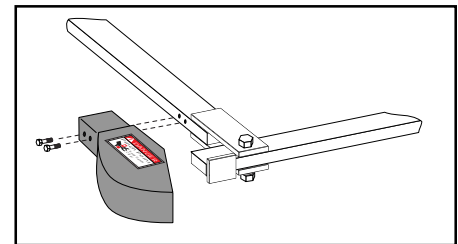

# Connecting Power to the Operator

**⚡ ⚠** Have a *licensed electrician* run 115 Vac wiring into a Field Wiring Connection Compartment (ON/OFF) box. The 115 Vac line will power the gate operator system. The circuit must be protected with a 15 A main disconnect breaker (*not provided*).

**⚡ ⚠** NOTE: Power and wiring connections **MUST** be installed by a licensed electrician in accordance with NEC (National Electric Code) and local codes.

**⚡ ⚠** NEVER run low voltage (e.g., accessory or receiver) wires in conduit containing 115 Vac wiring.

After the gate operator is connected to the 115 Vac power supply, the limit switches can be set. See **ADJUSTING THE LIMIT SWITCHES** on the next page.

# ADJUSTING THE LIMIT SWITCHES

The limit switches determine how far the gate travels to open and close. The closer the limit nut is to the limit switch, the less distance the gate will travel to open or close. Adjust the limit switches by moving the limit nuts.

**⚠️ ⚠️ MAKE SURE THE OPERATOR POWER IS OFF BEFORE ATTEMPTING TO ADJUST THE LIMIT SWITCHES.**

## Limit Adjustment Lock

Lift and release the limit switch plate to unlock the limit nuts (see illustration at right). Using a fingertip, roll the limit nuts along the travel shaft until the correct open and closed gate positions are determined.

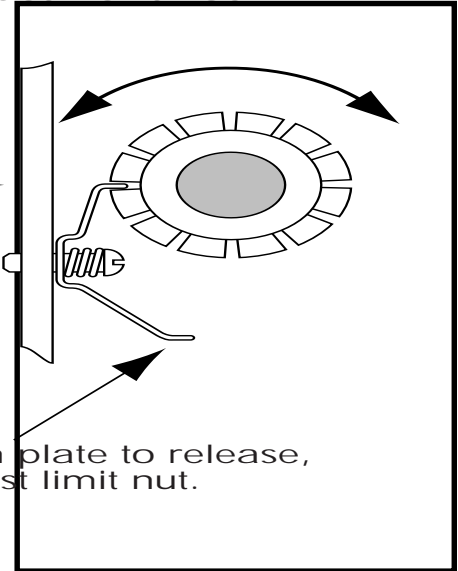

**If the operator is mounted to the LEFT** of the gate (see illustration below): the left limit switch adjusts the open position. The right limit switch adjusts the closed position.

**If the operator is mounted to the RIGHT** of the gate (see illustration below): the right limit switch adjusts the open position. The left limit switch adjusts the closed position.

Test the operator to verify that the limit switches are properly set. The operator should open and close the gate completely. After properly setting the limit switches, the control board must be set according to the operator application. The system accessories should also be connected to the control board.

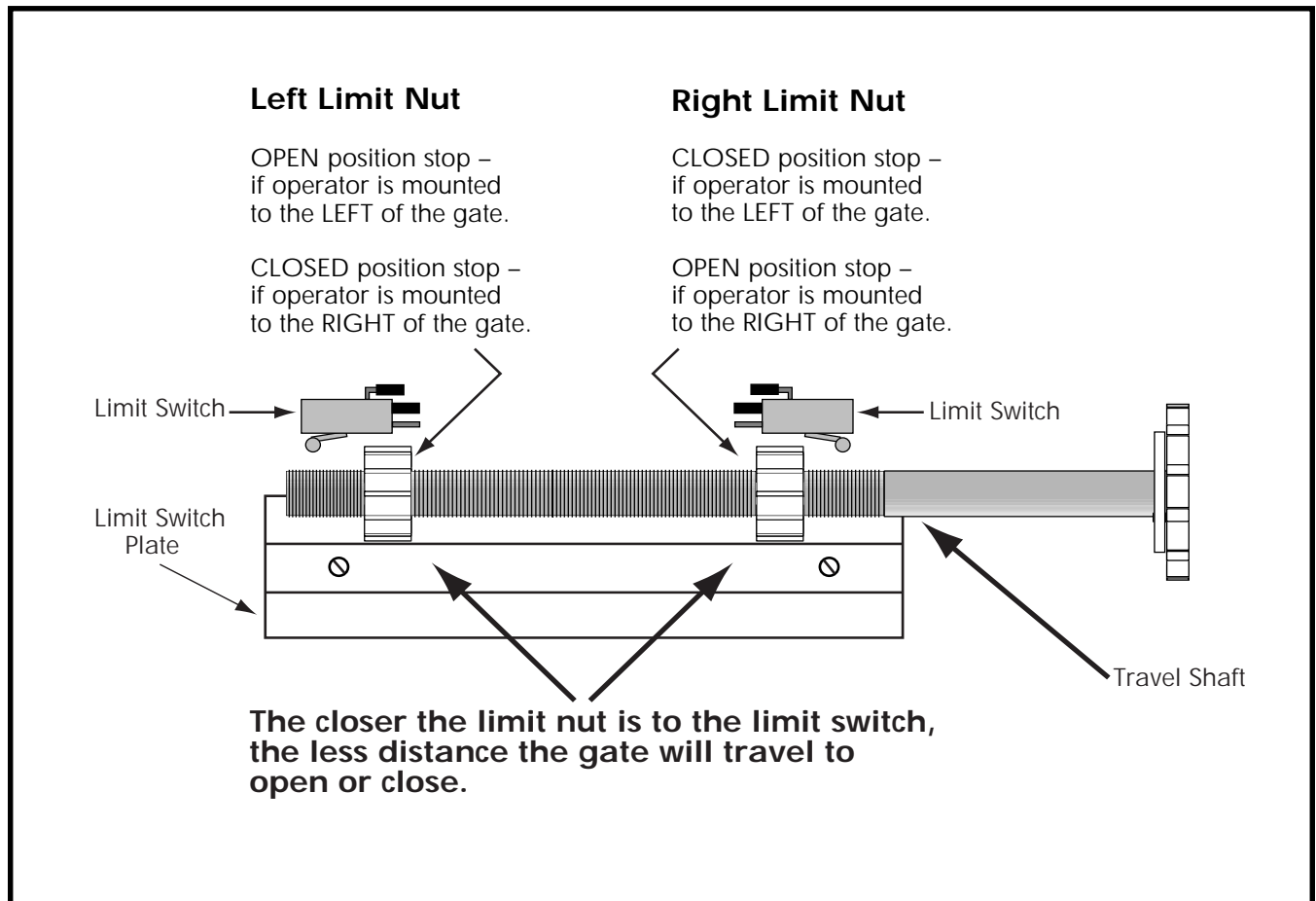

# ADVANCED GATE OPERATOR CONTROL BOARD

(Not Actual Size)

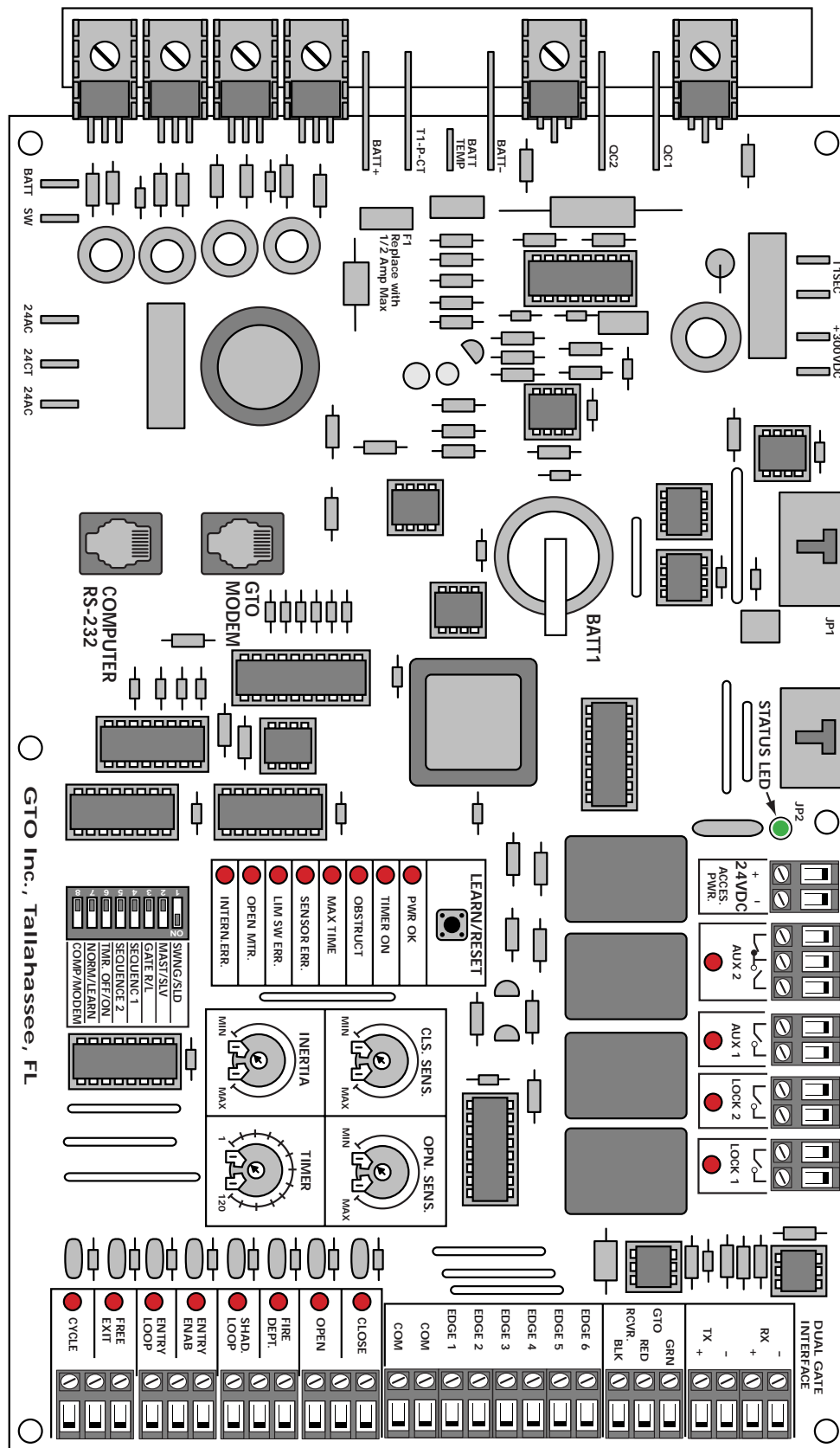

GTO Inc., Tallahassee, FL

# CONTROL BOARD SETTINGS

THESE SETTINGS SHOULD BE ADJUSTED ONLY BY AN EXPERIENCED INSTALLER OR TECHNICIAN!

- LEARN/RESET:** 1) Use to set transmitter code in control board memory.  
2) Press this button to clear the diagnostic and error LEDs.

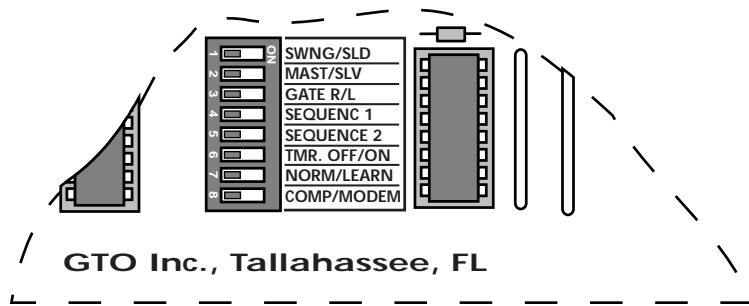

## DIP switches

(To change these settings, you must turn power OFF; move the switch; then turn power back ON.)

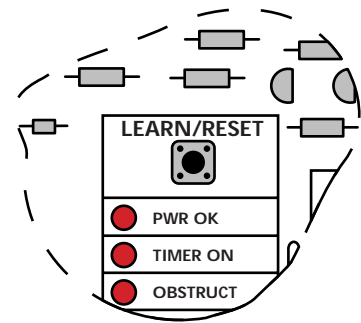

**SWNG/SLD** (swing or slide gate operation): **SWNG** = swing gate **SLD** = slide gate [factory default is **SWNG**].  
**MAST/SLV** (master or slave unit): This DIP switch must be set to **MAST** for single gate applications. For dual gate applications set one control board to **MAST** and the other to **SLD** [factory default is **MAST**]. *See installing a Dual System on pages 24-25.*

**GATE R/L** (gate opens right or left): The direction a gate opens is determined by standing inside the property and facing toward the gate. Set the DIP switch to **R** for a gate that opens to the right. Set the DIP switch to **L** for a gate that opens to the left.

**SEQUENCE 1:** This DIP switch is used for sequencing swing gates [factory default is OFF]. **For single gate applications this switch MUST be set to OFF.**

**SEQUENCE 2:** Same as **SEQUENCE 1** above.

**TMR. OFF/ON:** (auto-close timer OFF or ON; close timer is set to 1 second at the factory): When this DIP switch is set to ON, the **CLOSE TIMER** potentiometer must be adjusted [factory default is OFF].

**NORM/LEARN** (normal control board mode or learn mode): Function not available on this control board (function will be activated on future boards).

**OPEN/CLOSE:** In the event of a low voltage lockout the operator will go to either the OPEN or CLOSE position and shut down. Set this DIP switch for for desired position.

**Potentiometers** (All potentiometers are set to **MIN** at the factory. The size and type of gate installation *must* be accommodated by adjusting the potentiometers. **HOWEVER**—potentiometer settings should not be used to compensate for worn, damaged, or incorrect gate hardware.)

**CLS. SENS.** (closing sensitivity): Adjusts obstruction sensitivity of the gate in closing mode. The **MIN** setting is for minimum gate force. The **MAX** setting is for maximum gate force (i.e., the operator will require greater resistance before obstructing).

**OPN. SENS.** (opening sensitivity): Adjusts obstruction sensitivity of the gate in opening mode (see **CLS. SENS.** above).

**INERTIA:** Fine tunes the operator obstruction settings in the open and close modes. This potentiometer can be adjusted to allow the operator to push against an obstruction for a maximum of 2 seconds before obstructing (i.e., stopping and reversing).

**CLOSE TIMER** (Controls the auto-close feature [factory default is 1 second]): disabled and enabled with the TMR. OFF/ON DIP switch (see **DIP switches** above). The potentiometer adjusts the amount of time the gate will remain open before it closes. The limits are 1 to 120 seconds.

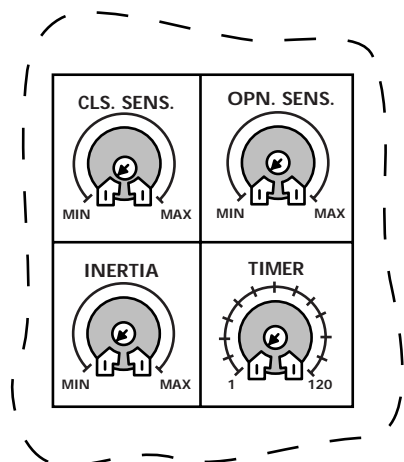

## Diagnostic LEDs *(Press LEARN / RESET to clear these LEDs)*

**PWR OK:** Power (115 Vac) is being delivered to the unit. *This light will not be on when operator is in "LEARN" mode and it will PLUSE when the system is on battery backup..*

**TIMER ON:** The auto-close timer has been enabled.

**OBSTRUCT:** An obstruction has been encountered.

**MAX TIME:** Indicates operator ran longer than 55 seconds without reaching a limit switch and the motor has shut OFF.

## Error Condition LEDs *(Press LEARN / RESET to clear these LEDs)*

**SENSOR ERR.:** Indicates obstruction sensing circuitry has malfunctioned.

**LIM SW ERR.:** Indicates a fault in the limit switch or limit switch wiring (this error cannot be reset by pressing the **LEARN/RESET** button).

**OPEN MTR.:** Control board does not detect the operator motor.

**INTERNERR.:** Indicates a microprocessor error has occurred. An internal error cannot be reset by pressing the **LEARN/RESET** button. The ON/OFF switch must be turned **OFF**, then back **ON** to reset the LED.

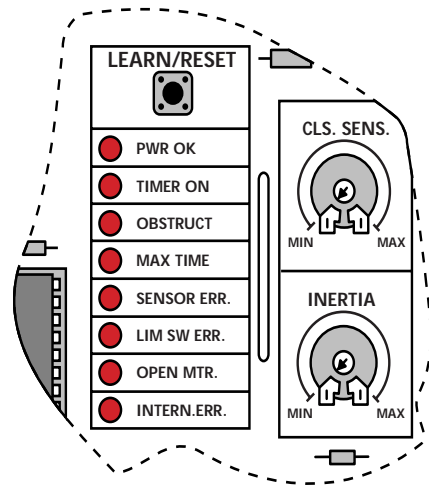

**Terminals** *(Note: use common connections for ground. To ground CLOSE/ OPEN, FIRE DEPT., SHAD. LOOP, SAFE LOOP, ENTRY LOOP, FREE EXIT, and CYCLE, use the center post).*

**DUAL GATE INTERFACE RX TX:** This terminal allows the addition of a second gate operator for dual gate systems. **ONLY** Belden Wire® (see **Installing a Dual Slide Gate System** on pages 24-25) is compatible with this terminal. **All four (4) connectors plus one (1) COMMON must be wired.**

**GTO RCVR.:** For connecting a **GTO receiver ONLY**. Other receivers may be connected to the 24VDC terminal block (see **CAUTION at 24VDC** on page 19).

**EDGE 1 – EDGE 6 :** These six terminals accommodate safety edges and photo beams.

**COM (common):** Terminal for connecting a ground wire.

**CLOSE/OPEN:** OPEN requires constant pressure on entry device to open the gate; CLOSE requires constant pressure on entry device to close the gate. **NOTE:** When a constant pressure entry device is installed the unit will not accept any other open or close input except FIRE DEPT and FREE EXIT (requires constant input).

**FIRE DEPT.:** N/O contact reserved for public safety agency use (e.g., fire box) only.

**SHAD. LOOP:** Shadow loop setting for swing gates.

**SAFE LOOP:** N/O contact that prevents the gate from closing if the safety device (ground loop, photo beam, etc.) is activated.

**ENTRY LOOP:** N/O contact for entry device.

**FREE EXIT:** N/O contact for an exit loop or exit wand.

**CYCLE:** N/O contact for doorbell button or key switch.

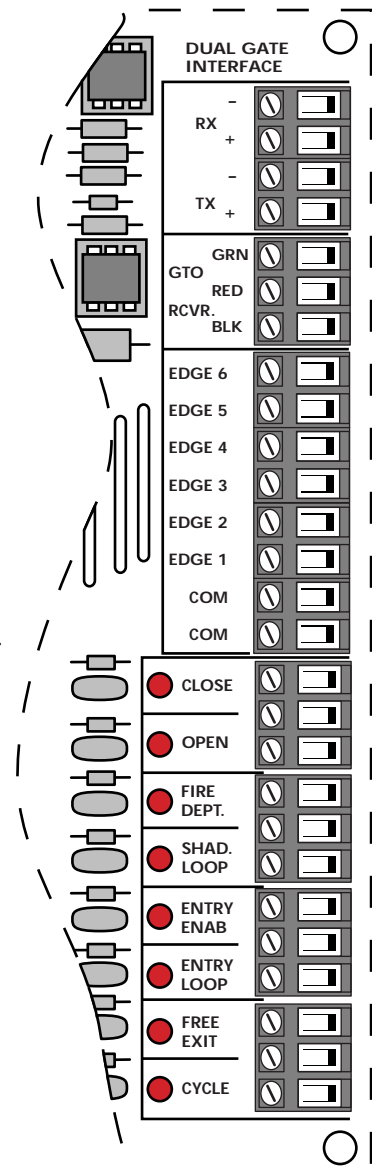

*continued on facing page...*

**24VDC:** Accommodates accessory power up to 1/2 A. **CAUTION: Accessories other than 24 Vdc or rated higher than 1/2 A require a separate power supply (not provided—See NOTE at Status LED below).**

**AUX2:** Activates devices such as another unit in a 2-stage security application.

**ALARM:** Activates devices such as lights or alarms when gate is obstructed.

**LOCK2:** Provides a contact closure when the gate *is* in motion.

**LOCK1:** Provides a contact closure when the gate is *not* in motion.

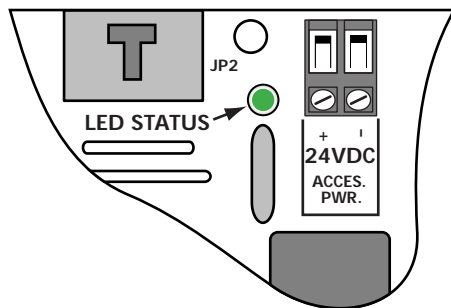
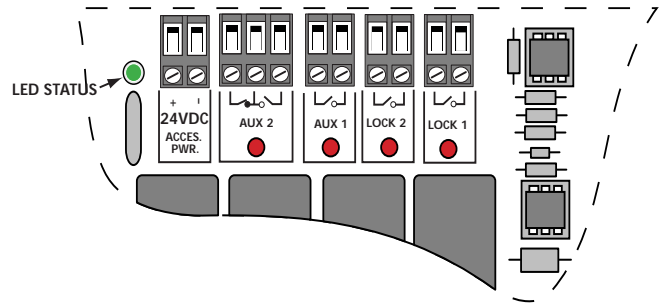

### Status LED

The green STATUS LED should be *on* when power is being delivered to the system. If the STATUS LED is not on or goes out, the current draw for the **24VDC** terminal may be **excessive**. Only accessories rated for **1/2 A or less** can be connected to the 24VDC terminal (see note at **24VDC** above).

### Battery Terminals

The battery terminals provide the GTO/PRO SW-5100 and GTO/PRO SW-6100 gate operators with back-up power in the event of an AC power failure. Two 12 V GTO back-up batteries are shipped installed and wired to the control board.

**⚡ ⚠ No adjustments or other connections to the batteries or terminals are necessary.**

The GTO back-up batteries should be replaced every five (5) years to prevent interruptions in gate operator function. **USE ONLY GTO APPROVED BACK-UP BATTERIES.** Call the GTO Service Department at (850) 575-0176 for more information.

### Inverter

**⚡ ⚠** A **390 V** inverter (bolted to the inner plate of the control box above the control board) controls the battery back-up feature of the GTO/PRO SW-5100 and GTO/PRO SW-6100 gate operators. The inverter will retain voltage for a minimum of 5 minutes after operator power is shut down.

**⚡ ⚠** The inverter is protected by a non-removable safety cover and a tamper-evident seal. **There are no serviceable parts in the inverter**— if the inverter fails to function properly, call the GTO Service Department at (850) 575-0176.

**⚡ ⚠ DO NOT ATTEMPT TO REMOVE THE SAFETY COVER FROM THE INVERTER! THE HIGH VOLTAGE OF THE INVERTER CAN CAUSE SERIOUS INJURY OR DEATH!**

**THE WARRANTY OF THE GATE OPERATOR IS VOID IF THE SAFETY COVER OR TAMPER-EVIDENT SEAL IS REMOVED FROM THE INVERTER.**

# ADVANCED CONTROL BOARD FEATURES

The GTO/PRO SW-5100 and GTO/PRO SW-6100 have two capabilities beyond the basic SW-5000 and SW-6000 units. They are:

## BATTERY BACK-UP

**IMPORTANT:** The unit was shipped with the battery backup inline fuse removed. This fuse (taped to the operator) must be installed inline for battery backup to function.

In the event of a power failure, the battery back-up function will automatically switch on. **The motor will run at 1/2 speed to indicate that normal AC power has failed. All operator features, safety devices, and accessories that are DC powered through the operator control board, will continue to function normally.** During normal operation (i.e., the operator is driven with AC power) the charging circuit maintains the charge of the two back-up batteries.

The batteries can perform up to 200 gate cycles before completely discharging. When AC power is restored, the back-up batteries will drop off-line **automatically**. *There is no need to reset the operator by turning the power switch OFF then back ON.*

The operator **ON/OFF** switch functions as a single pole, double throw. This means when the operator is shut down with the switch, the battery back-up function will also be shut down.

## SOFT START / SOFT STOP

The GTO/PRO SW-5100 and GTO/PRO SW-6100 units have a soft start and soft stop feature that minimizes wear on mechanical and electrical components. The inverter regulates motor voltage to slowly start the gate, steadily increase gate speed, and then slowly decrease gate speed before it stops. **No adjustment of gate acceleration and deceleration rates is necessary.**

After the appropriate connections and settings have been made to the control board, the transmitter should be set to a personal code. This code must be “taught” (i.e., stored in) to the control board memory. Proceed to **SETTING A PERSONAL TRANSMITTER CODE** on the next page.

# SETTING A PERSONAL TRANSMITTER CODE

All GTO transmitters are set to a standard code at the factory and are ready to operate the GTO/PRO SW-5100 & GTO/PRO SW-6100 series operators. For safety and security, however, we **strongly recommend** that the factory setting be replaced with a personal code. Follow the directions below:

## 1. Remove the Transmitter Cover

Grasp the sides of the access cover and slide it away from the transmitter button (see illustration). When the access cover is removed, the battery and the DIP switches will be exposed. To set a new code, use a small screwdriver to move the switches.

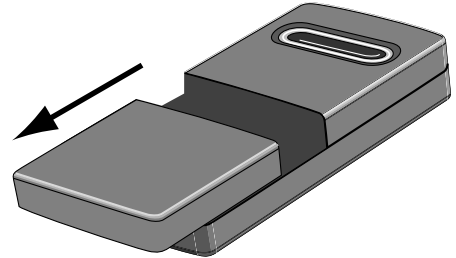

## 2. Set the DIP Switches

There are nine (9) DIP switches; each of which can be placed in three different positions (+,0,-). **DO NOT** set all the switches in the same position, such as all +, all -, or all **zeros**. Once the DIP switches have been set to a personal code, replace and close the access cover.

**WARNING: No other adjustments should be made inside the transmitter.**

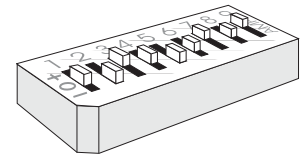

## 3. "Teach" the New Code to Control Board Memory

- A. Turn power to unit **OFF**
- B. While pressing the **RST/LEARN** button turn the operator power **ON**. Release **RST/LEARN** button. Wait 15 seconds for receiver to charge.
- C. Press transmitter button until **PWR OK** light comes on.

# MOUNTING THE RECEIVER

Check the receiver range before **permanently** mounting it. Wire receiver to the control board at the terminal marked "GTO RCVR."

Consider the following when mounting the receiver:

- Cable length is 20 feet. **DO NOT** splice receiver cable!
- Run the receiver cable through PVC conduit to prevent damage to cables. **DO NOT** run cable through metal conduit, because it can decrease signal range. **DO NOT** run cable with AC wiring.
- **DO NOT** mount receiver on metal fence or post, because it will decrease signal range.
- **DO NOT** overtighten mounting screws; it may warp the receiver housing and damage the weather seal.
- The receiver range can vary from 50 feet to 100 feet depending upon weather, topography, and outside interference.

### FCC Regulation

This device complies with FCC rules Part 15. Operation is subject to the following conditions:

1. This device may not cause harmful interference.
2. This device must accept an interference that may cause undesired operation.

Transmitter distance may vary due to circumstances beyond our control. **NOTE: The manufacturer is not responsible for any radio or TV interference caused by unauthorized modifications to this equipment. Such modifications could void the user's authority to operate the equipment.**



# INSTALLING SAFETY COVERS ON THE OPERATOR

**⚠** The movement of the gate arm assembly presents the possibility of physical injury to installers, maintenance technicians, and consumers/end users. The installer **must** know the areas of the operator where a person's hands and fingers could be pinched. Furthermore, the installer **must** take reasonable precautions when installing a gate operator to prevent this type of injury (UL 325; 51.8.4 [a], [3]). GTO **requires** safety covers to be installed over the "pinch points" of the gate operator. In particular, the upper and lower splines, the knuckle joint of the gate arm assembly, and the operator itself must be covered.

Remove the gate arm assembly from the gate operator before attempting to install the safety covers. Detach the gate bracket from the support bar and remove the  $\frac{3}{8}$ " bolt from the spline retainer. Lift the upper spline and the gate arm assembly (as a unit) off the output shaft of the gear reducer. **NOTE: check to make sure the knuckle cover and its bolts are still in place** (see page 14). In addition, make sure the safety edges, warning signs, and pedestrian gate (if necessary) are installed (review pages 6-7).

1. Lower the operator housing into position over the operator. Fasten the housing to the operator with (2)  $\frac{3}{8}$ " washers and chrome acorn nuts in the front and (2)  $\frac{3}{8}$ " washers and  $\frac{3}{8}$ " x 1" bolts on the sides..
2. Reattach the upper spline and the gate arm assembly (see pages 13 and 14) to the operator.
3. Fasten the pivot cover over the upper spline with (3)  $\frac{1}{4}$ " x 1" bolts.
4. If the knuckle cover is not already in place, fasten it over the knuckle joint of the gate arm assembly with (2)  $\frac{1}{4}$ " x 1" bolts.

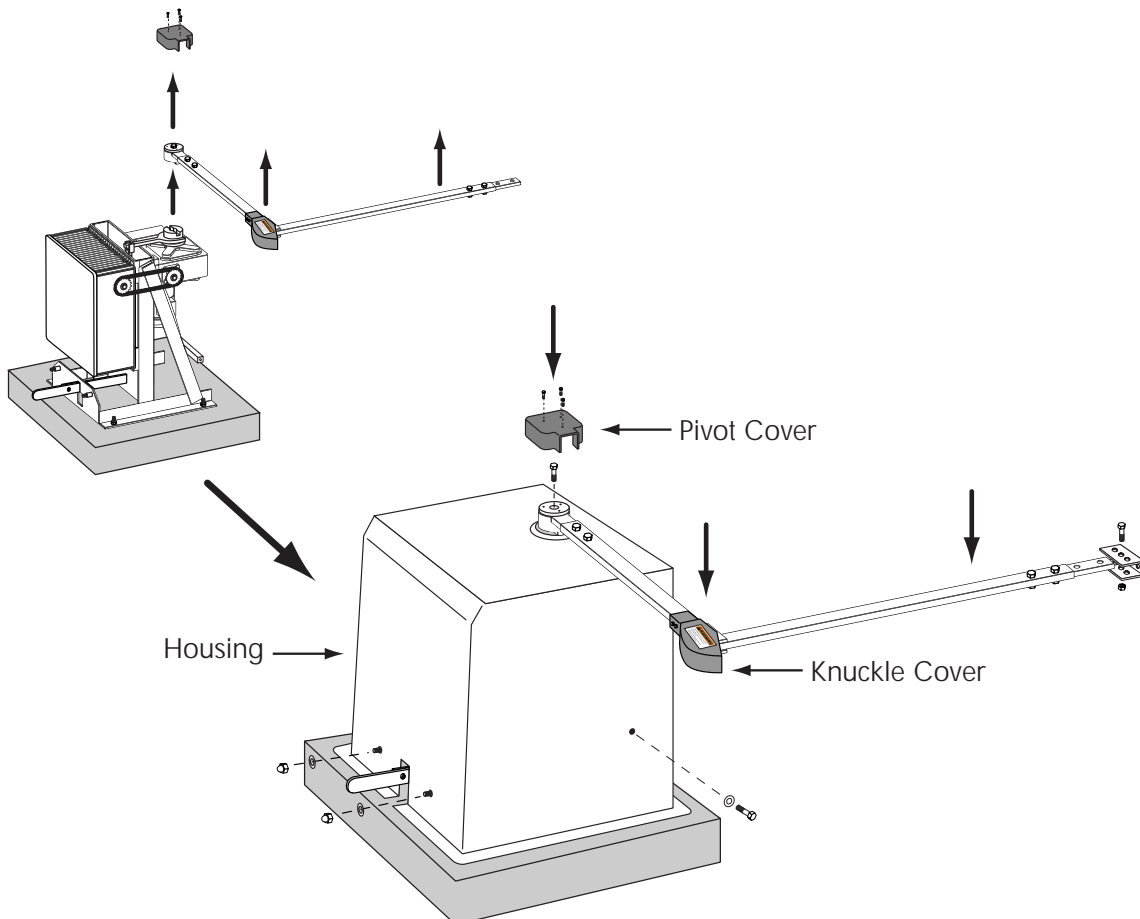

The installation is complete. Test the operator, accessories, and safety devices for correct function. Read and fill out the **INSTALLATION CHECK LIST** on the back cover of this manual.

# COMPATIBLE SAFETY DEVICES

Although GTO **strongly recommends** the use of safety devices, we do not endorse any specific brand names. Below is a list of some products compatible with GTO operators systems, some of which require their own power supply. Check with the individual manufacturer for specific power needs.

**Only use products that are certified and listed to be in compliance with national and regional safety codes.** Check with manufacture to insure product compatibility.

## Free Exit and Safety Loops

Advanced American Access, Inc.  
9345 Melvin Ave., Warehouse "8"  
Northridge, CA 91324-2465  
Phone (800)368-7921 \* Fax (800)304-4111

EMX. Inc.  
15437 Neo Parkway  
Cleveland, OH 44128  
Phone (800)426-9912 • Fax (216)560-9884

Perferred Technology Group  
2741B Lititz Pike  
Lancaster, PA 17601  
Phone (800)223-4743 • Fax (717)560-1700

Sarasota Automation, Inc.  
1500 N. Washington Blvd.  
Sarasota, FL 34236  
Phone (941)366-8770 • Fax (941)365-0837

## Emergency Overrides

Siren Operating Signal  
3315 Addison Ave. E.  
Twin Falls, ID 83301  
Phone (800)767-4283 • Fax (208)734-0829

## Miscellaneous / Gate Hinges

DAC Industries, Inc.  
982 Maple Hill, S.E.  
Grand Rapids, MI 49546  
Phone (800)888-9768 • Fax (616)235-29011

# Installing a Dual Slide Gate Operator System

**IMPORTANT:** With a dual gate system certain control board settings and connections are required on the MASTER unit only and some are required on both the MASTER and the SLAVE unit. The list below gives an overview.

## MASTER

- Gate Sequencing (set on MASTER, left OFF on SLAVE)
- Alarms (wired to MASTER only)
- Entry Devices (all entry/exit devices, shadow loops, Fire Dept. and free exit devices are wired to the MASTER unit)
- Adjustable Auto Close (MASTER controls opening and closing for both gates)
- Locks are controlled by the MASTER unit)

## BOTH (Master & Slave)

- Safety Edges (wired to unit it controls)
- Adjustable Inertia and Adjustable Sensitivity (each unit controls its own gate)

**NOTE:** In a dual gate system the diagnostic LED lights on the MASTER unit are used to diagnose both units. (The LED lights on the SLAVE are nonfunctional.)

## Setting Dual Gate Sequence

SW-5100 and SW-6100 operators come from the factory with the Sequence 1 and 2 DIP switches set to OFF, for single gate operation. **DIP Switches must be changes to accommodate dual gate operation.** The chart below shows the various combinations to suite your specific application.

**IMPORTANT:** The SEQUENCE DIP Switch Settings are set on the MASTER Operator only -- the SEQUENCE DIP Switch Settings on the SLAVE Operator are set to OFF only.

Seq 1 set to:	Seq 2 set to:	Operation
OFF ----	OFF ----	(FACTORY) No slave gate attached, Master will not wait for slave to complete.
ON ----	OFF ----	Both units operate together. (This setting can not be used if you are using CLOSED POSITION STOP PLATES or a LOCK.)
OFF ----	ON ----	Master unit Opens First, Slave unit closes First. (Use this is the setting with CLOSED POSITION STOP PLATES and/or LOCK.)
ON ----	ON ----	Master unit Opens and Closes First. (This setting can not be used if you are using CLOSED POSITION STOP PLATES or a LOCK.)

## Wiring the Dual Gate Syatem

A dual gate operator system requires a 5 wire connection between two single units.

**NOTE:** 22 AWG, type 8723, 2-pair shielded (with one ground) wire manufactured by **Belden Inc.** is the **ONLY** wire compatible for use with the DUAL GATE INTERFACE terminal. **Read warnings below.**

Adjust the **MAST/SLV** for each unit; select unit for “master” (**MAST**), and the other for “slave” (**SLV**). Adjust the **GATE R/L** DIP switches for each unit; select one for gate **R** (gate opens to the right), and the other for gate **L** (gate opens to the left). Connect the receiver for the **MAST** unit only.

## Dual Gate Interface

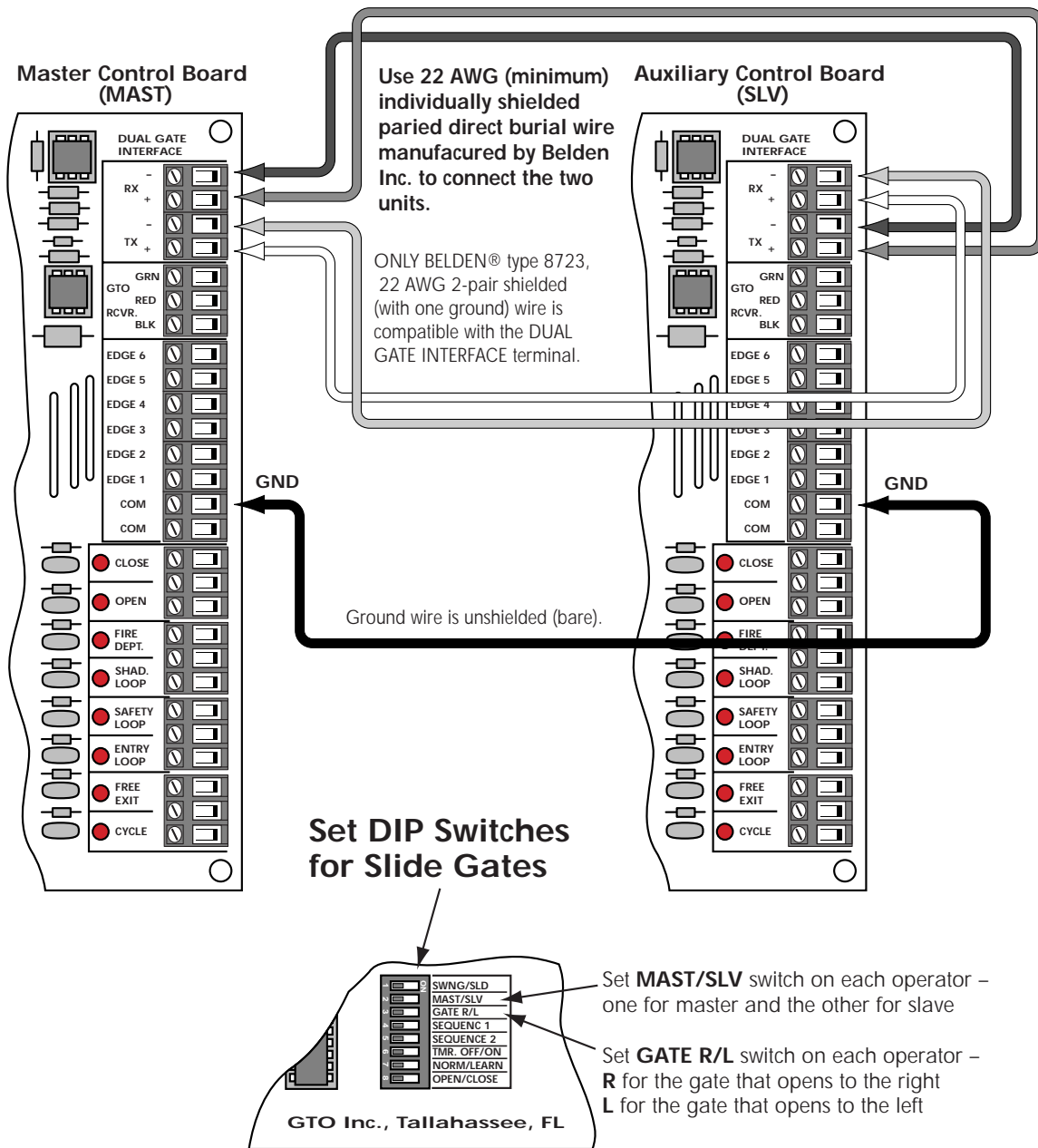

**⚠ The DUAL GATE INTERFACE RX TX terminal requires 22 AWG direct burial wire manufactured by Belden Inc. BELDEN WIRE® is the ONLY wire compatible with this terminal. If another manufacturer's wire is connected, the DUAL GATE INTERFACE terminal will NOT FUNCTION!**

**⚠ BELDEN WIRE® must be run through its own PVC conduit to protect it from damage. BELDEN WIRE® should NEVER be run in conduit containing ac wiring!**

*All four (4) connectors plus one (1) COMMON must be wired.*

**NOTE: A separate gate or entrance must be installed for pedestrian use.**

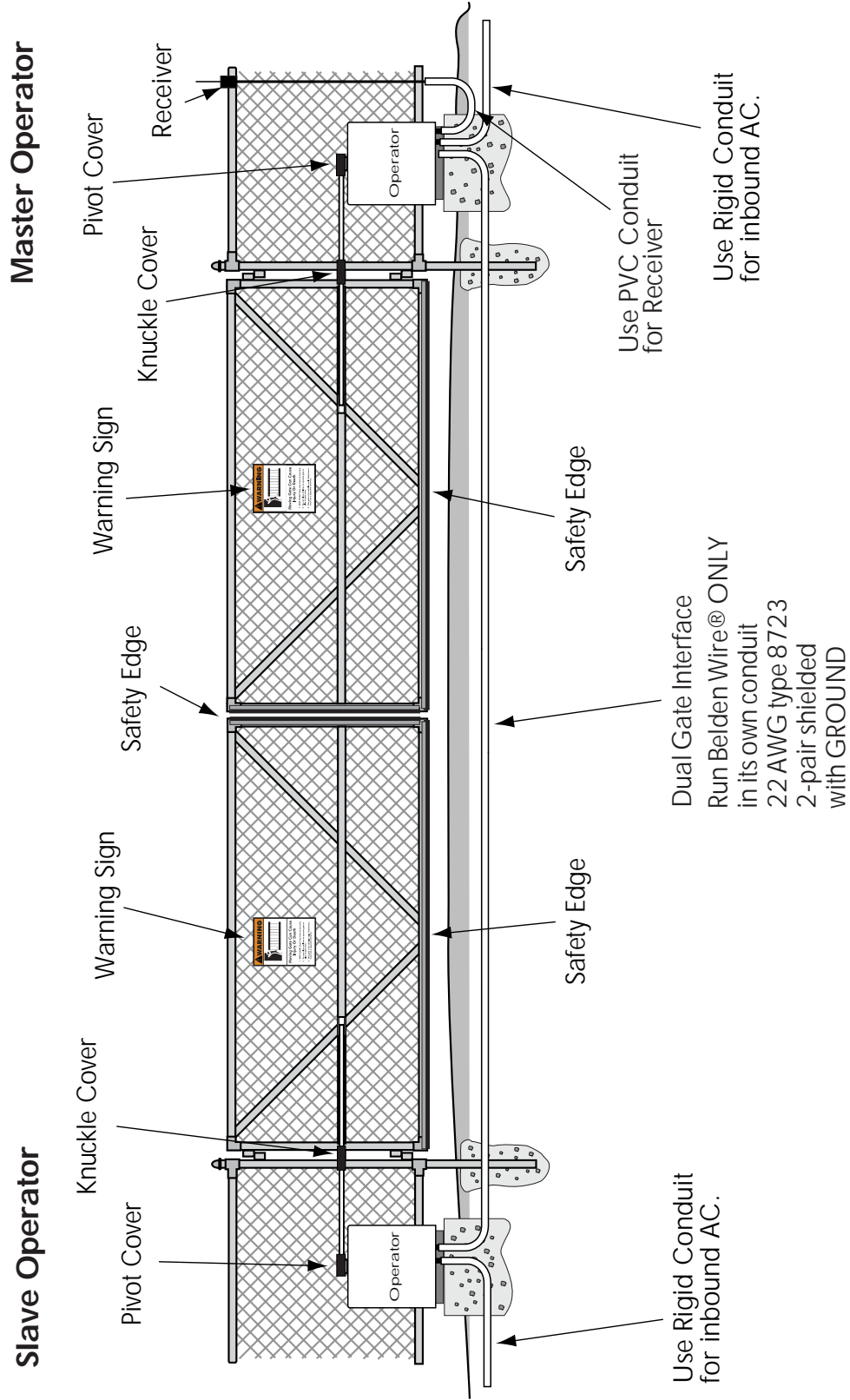

# MAINTENANCE

**WARNING: ALWAYS TURN OPERATOR OFF BEFORE ADJUSTING OR SERVICING IT.**

## Maintenance Schedule:

Test the gate operator, accessories, and safety devices *monthly*.  
Service the gate operator, accessories, and safety devices *regularly*.

## Maintenance Checklist

Test the safety edges (Grasp edges and squeeze).  
Check the obstruction settings (in both open and close modes).  
Check for wear on all moving parts, and tighten bolts as necessary.  
Check the gear box for any sign of oil leakage. If the gearbox is leaking, call the GTO Service Department for assistance. **DO NOT ADD OIL!**  
Check hinges on the gate and lubricate if needed.  
Check for loose or corroded wires.  
Clean and grease the upper and lower splines twice per year.  
Make sure the warning signs (*see page 7*) are installed.

**NOTES:** [1] Always use the proper lubricant for your area. Check the temperature range of the lubricant; lubricant with an improper temperature range may cause the unit to stop operating or cause an obstruction condition.

[2] In extremely cold climates, maintain the proper operating temperature of the unit by installing heat tape around the gear reducer (*see illustration*).

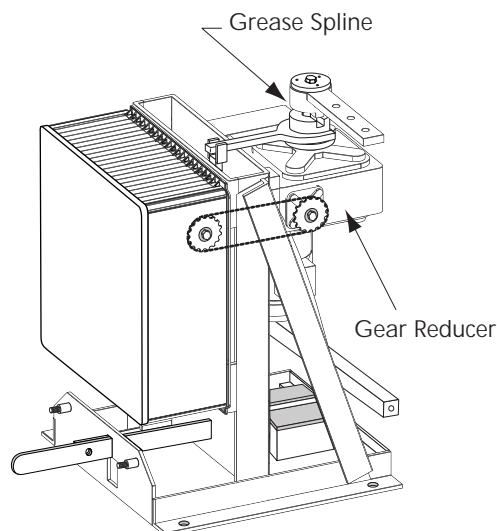

# TROUBLE SHOOTING GUIDE

**WARNING: ALWAYS TURN OPERATOR OFF BEFORE  
ADJUSTING OR SERVICING IT.**

1. *If the **PWR OK** light will not come on:*
  - A. Check the operator for inbound power.
  - B. The operator is in “learn” mode (*see* **SETTING A PERSONAL TRANSMITTER CODE** on page 19).
  
2. *If the unit does not function:*
  - A. Check the operator for inbound power.
  - B. Make sure the ON/OFF switch is in the ON position.
  - C. Control board may be damaged; call the GTO Service Department.
  
3. *If the control board lights are on but the unit will not operate:*
  - A. Press the reset button on the motor.
  - B. If you are using the transmitter to open the gate, jumper the **CYCLE** terminal. If the unit operates, the transmitter batteries may be discharged. Install fresh batteries in the transmitter. If problem persists, the receiver may be damaged. Call the GTO Service Department.
  - C. Disconnect the accessories from the control board and jumper the **CYCLE** terminal. If the unit operates; then reconnect each accessory, and test each; one at a time.
  
4. *If the gate starts; then stops or reverses:*
  - A. The transmitter button is being held too long.
  - B. If using a loop entry or exit, make sure the wires are connected to the correct terminal.
  - C. The gate operator may have been improperly installed.
  - D. The gate hinges are worn.
  - E. The gate is not level.
  - F. The obstruction level setting is too low.
  
5. *If the gate opens but will not close:*
  - A. The auto-close timer (**TMR. OFF/ON** DIP switch) is OFF.
  - B. An input (e.g., loop relay, push button, etc.) may be stuck.
  - C. Limit switch may be defective.
  
6. *If the thermal overload button constantly trips (i.e., “pops out”):*
  - A. Motor current may be excessive; call the GTO Service Department.
  - B. Check wire connections.
  - C. The gate has cycled too many times for the ambient temperature.

# WARRANTY AND REPAIR SERVICE

If the GTO gate operator system is not working properly, please follow the steps below:

## Instructions for the Consumer/End User:

1. Call your dealer or installer for service. *Only an experienced technician may service this unit.*
2. If your dealer or installer is unable to solve the problem, they will contact the GTO Service Department.

## Instructions for the Dealer/Installer:

1. Call the GTO Service Department at (850) 575-0176 to discuss the problem with a service technician.
2. If repair or replacement is necessary, you will be assigned a **Return Goods Authorization Number (RGA)**.
3. Carefully pack the component(s) authorized for return and write the RGA number on the outside of the package in **LARGE BOLD PRINT**. Ship freight prepaid to **GTO, Inc., 3121 Hartsfield Road, Tallahassee, FL 32303**. NOTE: GTO products shipped without a Return Goods Authorization Number (RGA) or shipped freight collect *will not* be accepted at the factory.
4. *If GTO, Inc. determines that the warranty covers the repair or replacement of your gate operator:*  
GTO will pay shipping costs (equivalent to United Parcel Service ground rate) for return to owner of items repaired under warranty.

**GTO Hours of Operation: Mon. – Thurs., 7:30 A.M. - 5:30 P.M. and Fri., 8:00 A.M. - 12:00 P.M. (ET)**

**Phone (850) 575-0176 • FAX (850) 575-8950**

**E-mail: techsupport@gtoinc.com • GTO Web site: www.gtoinc.com**

## GTO/PRO AC Powered Gate Operator Limited Warranty

GTO/PRO AC powered gate operators are warranted by the manufacturer against defects in materials and manufacturer workmanship for a specific period of time beginning from the date of purchase, *provided recommended installation procedures have been followed.*

**The warranty period for *residential* installations is five (5) years for mechanical parts; three (3) years for electronic components. The warranty period for *commercial* installations is three (3) years for mechanical parts; two (2) years for electronic components.**

In the case of product failure due to defective material or manufacturer workmanship within the warranty period, the operator will be repaired or replaced (at manufacturer's option) at no charge to the customer, if returned freight prepaid to GTO, Inc., 3121 Hartsfield Road, Tallahassee, Florida 32303. **IMPORTANT: Call (850) 575-0176 or Fax (850) 575-8950 for a Return Goods Authorization (RGA) number before returning to factory.** Products received at the factory without an RGA number *will not* be accepted. Replacement or repaired parts are covered by this warranty for the remainder of the warranty period or six (6) months, whichever is greater. GTO will pay shipping charges (equivalent to United Parcel Service ground rate) for return to owner of items repaired under warranty.

The manufacturer will not be responsible for any charges or damages incurred in the removal of the defective parts for repair, or for the reinstallation of those parts after repair. This warranty shall be considered void if damage to the product(s) was the result of improper installation or use, tampering, connection to an improper power source, or if damage was caused by lightning, wind, fire, flood, insects or other natural agent. This warranty gives you specific legal rights, and you may also have other rights which may vary from state to state. This warranty is issued in lieu of all other warranties, expressed or implied. **NOTE: Verification of the warranty period requires copies of receipts or other proof of purchase. Please retain these records.**

After the warranty period, GTO or one of its authorized service centers will make any necessary repairs for a nominal fee. Call GTO at (850) 575-0176 for more information.



# INSTALLATION CHECK LIST

The installation of this operator conforms to CLASS \_\_\_\_\_.

The installer verifies that (each item must be checked):

- Required safety edges were installed.
- Required pivot cover and knuckle cover were installed.
- The knuckle cover warning decals (2) were affixed to the knuckle cover.
- Customer was informed that this gate is for vehicular use **ONLY**. Pedestrians **MAY NOT** use this gate.
- A separate gate or entrance was installed for pedestrian use.
- All warning signs and labels were installed as specified in the **IMPORTANT SAFETY INSTRUCTIONS**.
  
- Safety instructions were reviewed with the customer.
- The **IMPORTANT SAFETY INSTRUCTIONS** manual was given to the customer.
- Customer was instructed about proper use of the foot pedal release.
- Customer was instructed about proper use of transmitter and (or) other entry controls.
- Customer was asked to fill out customer support card and mail it to GTO, Inc.
- Customer was asked to retain **all receipts** (receipts provide proof of warranty).
- Customer was asked to retain **IMPORTANT SAFETY INSTRUCTIONS**, etc. for future reference.
- The completed installation was photographed from both the front and back of the gate. Photo was dated.

\_\_\_\_\_  
Customer's Signature

\_\_\_\_\_  
Date

\_\_\_\_\_  
Installer's Signature

\_\_\_\_\_  
Date